



Rail

SOLUTION GUIDE

Edition 1/19, valid from 10/2019



A Rolls-Royce
solution



Certified quality	04	Repowering	36
General specifications	06	Automation and Peripheral Systems	38
Engine designation	07	All products and benefits at a glance	
Selection guideline/product portfolio	08	MTU PowerControl Automation	
MTU PowerPacks for railcars, underfloor installation		SafeMon	
315 kW - 700 kW		Powerline for Series 4000	
Diesel engines for push-pull trains and locomotives		CaPoS powerline	
783 kW - 3300 kW		CaPoS smart edition	
PowerPacks for railcars	10	Parts & Service	56
Hybrid PowerPacks for railcars	12	Complete lifecycle solutions	
Applications	14	Exhaust emissions	66
References of Diesel engines and PowerPacks in railcars/push-pull trains and locomotives	32	Engines overview	
References of Diesel engines and PowerPacks in special-purpose rail vehicles	34	Engine technology	
		Exhaust emission legislation for rail application	
		Conversion table	75

PIONEERING THE POWER THAT MATTERS

Rolls-Royce provides world-class power solutions and complete life-cycle support under our product and solution brand MTU. Through digitalization and electrification, we strive to develop drive and power generation solutions that are even cleaner and smarter and thus provide answers to the challenges posed by the rapidly growing societal demands for energy and mobility. We deliver and service comprehensive, powerful and reliable systems, based on both gas and diesel engines, as well as electrified hybrid systems. These clean and technologically-advanced solutions serve our customers in the marine and infrastructure sectors worldwide.

A solution provider

MTU systems power the largest yachts, the strongest tugboats and the biggest land vehicles and provide energy for the world's most important mission-critical applications. Through advanced solutions such as microgrids, we integrate renewable energies and manage the power needs of our customers.

Our customized service offerings help you maximize uptime and performance and are supported by our digital solutions, which enable remote monitoring, predictive maintenance and a range of other benefits that keep your systems running at their best.

For over 110 years, we have provided innovative power solutions for our customers – meeting even the most demanding drive requirements. Our products and services span a wide range of applications and power needs, with both standard and customized options.

An expert in technology

As part of Rolls-Royce, we have long been known for cutting-edge innovation and technological leadership in product development. That same spirit of innovation inspires our sustainability efforts. Our focus is on developing and implementing system solutions that both maximize efficiency and reduce emissions -- which in turn work to reduce our impact on the environment.

A passionate and reliable partner

We at Rolls-Royce spend every day working together with our customers, to deliver engines, systems and complete life-cycle solutions that best fit your needs. We understand that each application is different and has its own specific demands. Our engineers embrace the challenge of finding the perfect solution for your unique power requirements. Every step of the way – from project planning, through design, delivery and commissioning; to the lifetime care of your equipment – we are dedicated to helping you get the most from your MTU investment.



1 ISO 9001

2 ISO 14001

3 UIC

GENERAL SPECIFICATIONS

Four-stroke diesel engine for traction

- Direct injection
- Liquid-cooled
- V or In-line configuration
- Suitable for mechanical, hydrodynamic, hydrostatic and electric power transmission

Power Definition

All power ratings are service standard power in accordance with UIC specifications.

Ambient air pressure:	1000 mbar
Height above sea level:	100 m
Intake air temperature:	25 °C
Charge-air coolant temp.:	45 °C

Fuel consumption in accordance with DIN/ISO 3046

Exhaust emission standards

EU = EU Nonroad Directive 97/68 EC
(as amended by 2010/26/EC)
EPA = US Regulation 40 CFR 9,85
UIC = International Railway Association

Please note, specifications are subject to change without further notice. All dimensions are approximate, more detailed information is included within installation drawings.

For further information on our rail products please contact your distributor or visit: www.mtu-solutions.com

EXPLANATION OF THE ENGINE DESIGNATION

Series 1800, 1600, 2000, 4000 – Example

16 V 4000 R 4 3 L

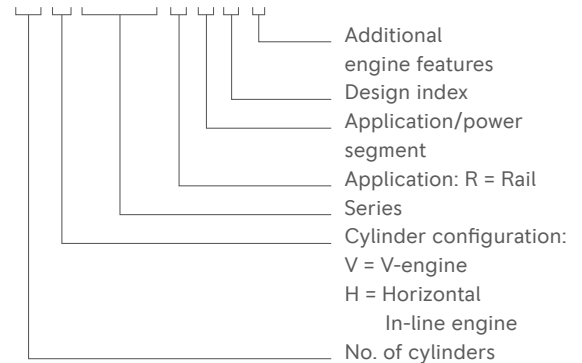

Additional engine features

Power uprated	L
Speed/power reduced	R
MTU PowerPack	P

PowerPacks and Engines

ALL ENGINES AT A GLANCE.

Railcars	315 kW - 700 kW	Page
MTU PowerPacks for railcars - underfloor/roof installation		10 - 19
Push-pull trains/locomotives	783 kW - 3300 kW	Page
Engines for push-pull trains and locomotives		20 - 31

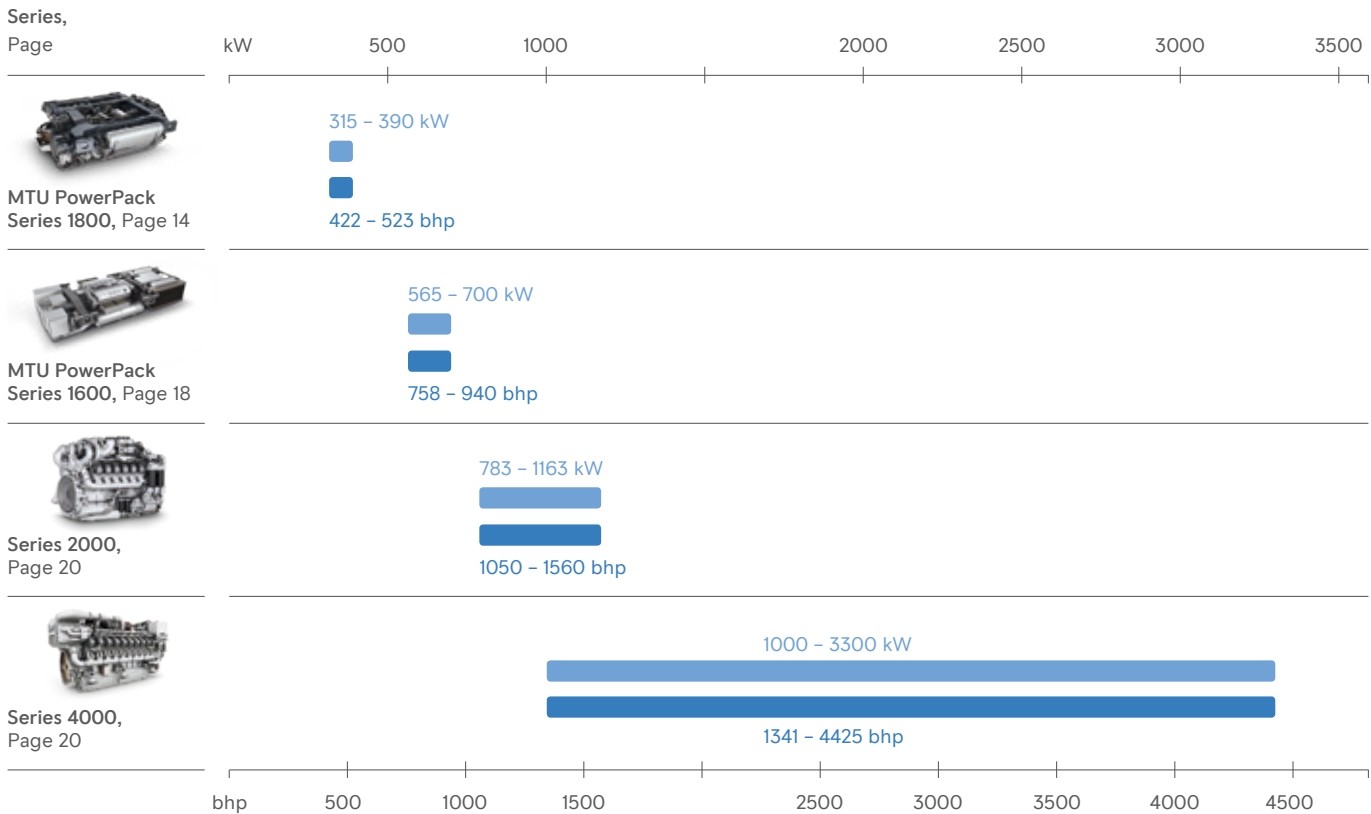

POWERPACKS FOR RAILCARS

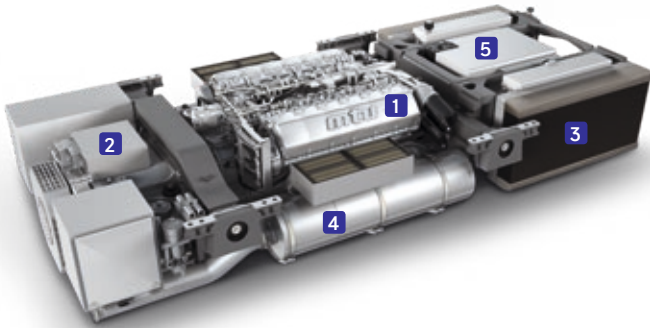

MTU PowerPack –

the highly compact, highly integrated solution.

Representation of a diesel-electric MTU PowerPack 12V 1600 with SCR technology (EU Stage IIIB). We have developed a series of individualized solutions involving a range of different frames and will use our extensive experience to find the appropriate solution to suit the requirements of any specific vehicle.

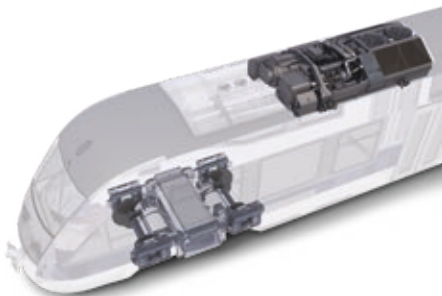

Roof mounting

Standard scope of supply

1 Engine	6H 1800 12V 1600
2 Power transmission	
Transmission	ZF 6 AP 2000R Voith T211 ZF 6 AP 2500R Voith T212
Traction alternator	Permanent magnet synchronous generator External excited synchronous generator Asynchronous generator
3 Cooling system	Underfloor or roof installation Hydraulic or electrical fan drive
4 Exhaust system	EU Stage IIIA compl. – exhaust silencer EU Stage IIIB – SCR exhaust aftertreatment system

Additional scope of supply

5 On-board power generation	28V/DC	3P-AC 50 Hz
	110V/DC	3P-AC 60 Hz
Air compressor		
Air conditioning comp.		
Preheating		
CaPos smart edition		
SafeMon		
Autom. oil replenishment		



Underfloor mounting

HYBRID POWERPACKS FOR RAILCARS

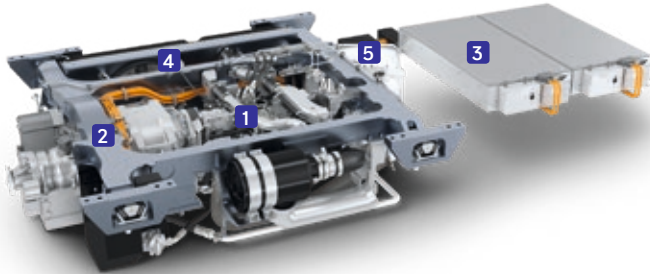

Hybrid PowerPack – the next generation of railcar drive systems.

Representation of a Hybrid PowerPack 6H 1800 with two MTU EnergyPacks and SCR technology (EU Stage IIIB). A proven hybrid drive system, ready for commercial operation: our modular platform offers customizable drive solutions that can be combined to ensure maximum efficiency, flexibility and sustainability.

Standard scope of supply

1 Engine	6H 1800	
	12V 1600	
2 Power transmission	Traction alternator	
	Diesel mechanical (ZF 6 AP 2500R and MTU electrical drive 200 (200 kWmech.))	
	Diesel electrical (370 kVA electrical drive)	
3 Battery system	MTU EnergyPack	
	15M1P	30.6 kWh
	15M2P	61.2 kWh
	15M3P	91.8 kWh
	15M4P	122.4 kWh
4 Cooling system	EU Stage IIIA compl. – exhaust silencer	
	EU Stage IIIB – SCR exhaust aftertreatment system	
5 Exhaust system	EU Stage IIIA compl. – exhaust silencer	
	EU Stage IIIB – SCR exhaust aftertreatment system	

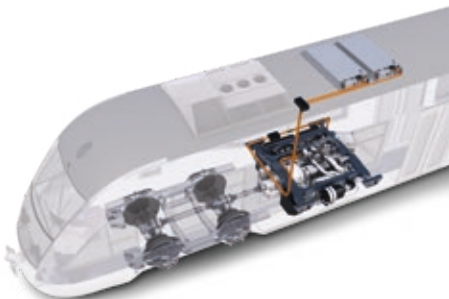

Roof mounting of MTU EnergyPacks

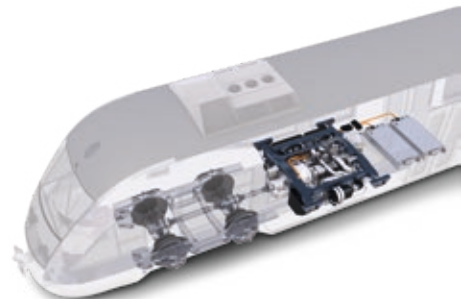

Underfloor mounting of MTU EnergyPacks

PowerPacks for railcars

UNDERFLOOR AND
ROOF INSTALLATION

© Federico Santagati

- For underfloor installation
- Horizontally mounted inline engines

PowerPack model		6H 1800 R81P	6H 1800 R82P
Rated power	kW (bhp)	315 (422)	335 (449)
Speed	rpm	1800	1800
Exhaust emissions		EU Stage IIIA compl./EPA Tier3 compl.	EU Stage IIIA compl./EPA Tier3 compl.
Fuel consumption at rated power	g/kWh	214	212
	l/h (gal/h)	81.2 (21.5)	85.6 (22.6)
at best point	g/kWh	198	198
Drive systems ¹⁾		DM/DH/DE	DM/DH/DE
PowerPack – dimensions & masses			
Length (L) ²⁾	mm	2600 - 4000	2600 - 4000
	(in)	(102.4 - 157.5)	(102.4 - 157.5)
Width (W) ²⁾	mm	2100 - 2800	2100 - 2800
	(in)	(82.7 - 110.2)	(82.7 - 110.2)
Height (H) ²⁾	mm	770 - 850	770 - 850
	(in)	(30.3 - 33.5)	(30.3 - 33.5)
Mass, dry ²⁾	kg	2900 - 4000	2900 - 4000
	(lbs)	(6393 - 8819)	(6393 - 8819)
Mass, wet ²⁾	kg	3050 - 4200	3050 - 4200
	(lbs)	(6724 - 9259)	(6724 - 9259)
Engine main data			
No. of cylinders/arrangement		6/inline	6/inline
Bore/Stroke	mm	128/166	128/166
	(in)	(5.0/6.5)	(5.0/6.5)
Displacement/cyl.	l (cu in)	2.14 (130)	2.14 (130)
Displacement, total	l (cu in)	12.8 (782)	12.8 (782)

1) Drive systems: DM = diesel mechanical; DH = diesel hydraulic; DE = diesel electrical

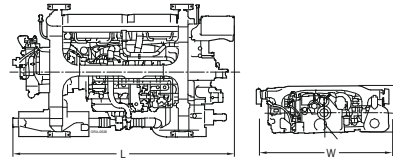
315 KW – 390 KW
(422 BHP – 523 BHP)

Dimensions: PowerPacks with standard equipment

6H 1800 R83P	6H 1800 R82P
360 (483)	390 (523)
1800	1800
EU Stage IIIA compl./EPA Tier3 compl.	EU Stage IIIA compl./EPA Tier3 compl.
212	216
92.0 (24.3)	101.5 (26.8)
198	198
DM/DH/DE	DM/DH/DE
2600 - 4000	2600 - 4000
(102.4 - 157.5)	(102.4 - 157.5)
2100 - 2800	2100 - 2800
(82.7 - 110.2)	(82.7 - 110.2)
770 - 850	770 - 850
(30.3 - 33.5)	(30.3 - 33.5)
2900 - 4000	2900 - 4000
(6393 - 8819)	(6393 - 8819)
3050 - 4200	3050 - 4200
(6724 - 9259)	(6724 - 9259)
6/inline	6/inline
128/166	128/166
(5.0/6.5)	(5.0/6.5)
2.14 (130)	2.14 (130)
12.8 (782)	12.8 (782)

2) Depending on scope of supply
Further variations on demand

PowerPacks for railcars

UNDERFLOOR AND
ROOF INSTALLATION

- For underfloor installation
- Horizontally mounted inline engines

PowerPack model		6H 1800 R75P	6H 1800 R75LP
Rated power	kW (bhp)	315 (422)	335 (449)
Speed	rpm	1800	1800
Exhaust emissions		EU Stage IIIB	EU Stage IIIB
Fuel consumption			
at rated power	g/kWh	198	199
	l/h (gal/h)	75.1 (19.9)	80.3 (21.2)
at best point	g/kWh	184	183
Drive systems ¹⁾		DM/DH/DE/ Hybrid	DM/DH/DE/ Hybrid
PowerPack – dimensions & masses			
Length (L) ²⁾	mm	2600 - 4000	2600 - 4000
	(in)	(102.4 - 157.5)	(102.4 - 157.5)
Width (W) ²⁾	mm	2100 - 2800	2100 - 2800
	(in)	(82.7 - 110.2)	(82.7 - 110.2)
Height (H) ²⁾	mm	770 - 850	770 - 850
	(in)	(30.3 - 33.5)	(30.3 - 33.5)
Mass, dry ²⁾	kg	2900 - 4000	2900 - 4000
	(lbs)	(6393 - 8819)	(6393 - 8819)
Mass, wet ²⁾	kg	3050 - 4200	3050 - 4200
	(lbs)	(6724 - 9259)	(6724 - 9259)
Engine main data			
No. of cylinders/arrangement		6/inline	6/inline
Bore/Stroke	mm	128/166	128/166
	(in)	(5.0/6.5)	(5.0/6.5)
Displacement/cyl.	l (cu in)	2.14 (130)	2.14 (130)
Displacement, total	l (cu in)	12.8 (782)	12.8 (782)

1) Drive systems: DM = diesel mechanical; DH = diesel hydraulic; DE = diesel electrical

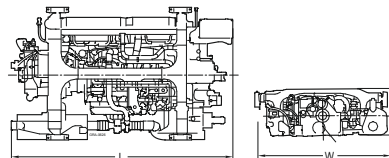
315 KW – 390 KW
(422 BHP – 523 BHP)

Dimensions: PowerPacks with standard equipment

6H 1800 R85P	6H 1800 R85LP
360 (483)	390 (523)
1800	1800
EU Stage IIIB	EU Stage IIIB
201	207
87.2 (23.0)	97.3 (25.7)
183	183
DM/DH/DE/ Hybrid	DM/DH/DE/ Hybrid
2600 - 4000	2600 - 4000
(102.4 - 157.5)	(102.4 - 157.5)
2100 - 2800	2100 - 2800
(82.7 - 110.2)	(82.7 - 110.2)
770 - 850	770 - 850
(30.3 - 33.5)	(30.3 - 33.5)
2900 - 4000	2900 - 4000
(6393 - 8819)	(6393 - 8819)
3050 - 4200	3050 - 4200
(6724 - 9259)	(6724 - 9259)
6/inline	6/inline
128/166	128/166
(5.0/6.5)	(5.0/6.5)
2.14 (130)	2.14 (130)
12.8 (782)	12.8 (782)

2) Depending on scope of supply
Further variations on demand

PowerPacks for railcars

UNDERFLOOR INSTALLATION

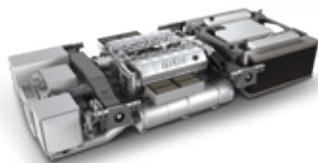

— For underfloor installation

PowerPack model		12V 1600 R70P	12V 1600 R70LP
Rated power	kW (bhp)	565 (758)	625 (838)
Speed	rpm	2100	2100
Exhaust emissions		EU Stage IIIB	EU Stage IIIB
Fuel consumption			
at rated power	g/kWh	207	207
	l/h (gal/h)	140.9 (37.2)	155.9 (41.2)
at best point	g/kWh	190	190
Drive systems ¹⁾		DM/DH/DE/ Hybrid	DM/DH/DE/ Hybrid
PowerPack – dimensions & masses			
Length (L) ²⁾	mm	3900 - 5000	3900 - 5000
	(in)	(153.5 - 196.9)	(153.5 - 196.9)
Width (W) ²⁾	mm	2100 - 2800	2100 - 2800
	(in)	(82.7 - 110.2)	(82.7 - 110.2)
Height (H) ²⁾	mm	850 - 950	850 - 950
	(in)	(31.5 - 37.4)	(31.5 - 37.4)
Mass, dry ²⁾	kg	4500 - 6500	4500 - 6500
	(lbs)	(9921 - 14330)	(9921 - 14330)
Mass, wet ²⁾	kg	4700 - 6750	4700 - 6750
	(lbs)	(10362 - 14881)	(10362 - 14881)
Engine main data			
No. of cylinders/arrangement		12	12
Bore/Stroke	mm	122/150	122/150
	(in)	(4.8/5.9)	(4.8/5.9)
Displacement/cyl.	l (cu in)	1.75 (107)	1.75 (107)
Displacement, total	l (cu in)	21.0 (1284)	21.0 (1284)

1) Drive systems: DM = diesel mechanical; DH = diesel hydraulic; DE = diesel electrical

565 KW – 700 KW
(758 BHP – 939 BHP)

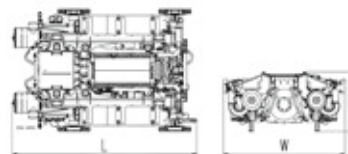

Dimensions: PowerPacks with standard equipment

12V 1600 R80P		12V 1600 R80LP	
Rated power	kW (bhp)	660 (885)	700 (939)
Speed	rpm	1900	1900
Exhaust emissions		EU Stage IIIB	EU Stage IIIB
Fuel consumption			
at rated power	g/kWh	200	200
	l/h (gal/h)	159.0 (42.0)	168.7 (44.6)
at best point	g/kWh	191	191
Drive systems		DE/ Hybrid	DE/ Hybrid
PowerPack – dimensions & masses			
Length (L) ²⁾	mm	3900 - 5000	3900 - 5000
	(in)	(153.5 - 196.9)	(153.5 - 196.9)
Width (W) ²⁾	mm	2100 - 2800	2100 - 2800
	(in)	(82.7 - 110.2)	(82.7 - 110.2)
Height (H) ²⁾	mm	850 - 950	850 - 950
	(in)	(31.5 - 37.4)	(31.5 - 37.4)
Mass, dry ²⁾	kg	4500 - 6500	4500 - 6500
	(lbs)	(9921 - 14330)	(9921 - 14330)
Mass, wet ²⁾	kg	4700 - 6750	4700 - 6750
	(lbs)	(10362 - 14881)	(10362 - 14881)
Engine main data			
No. of cylinders/arrangement		12	12
Bore/Stroke	mm	122/150	122/150
	(in)	(4.8/5.9)	(4.8/5.9)
Displacement/cyl.	l (cu in)	1.75 (107)	1.75 (107)
Displacement, total	l (cu in)	21.0 (1284)	21.0 (1284)

2) Depending on scope of supply
Further variations on demand

Engines

FOR PUSH-PULL TRAINS
AND LOCOMOTIVES

- For new locomotives or repowering
- Economical space requirements

Engine model		12V 2000 C66R ²⁾	8V 4000 R43
Rated power	kW (bhp)	783 (1050)	1000 (1341)
Speed	rpm	1800	1800
Exhaust emissions		Emission optimized w/o certificate	EU Stage IIIA compliant ¹⁾ / UIC IIIA
Fuel consumption at rated power	g/kWh	200	206
	l/h (gal/h)	–	248.2 (65.6)
at best point	g/kWh	198	194
Engines – dimensions & masses			
Length (L)	mm (in)	2030 (80)	2000 (78.7)
Width (W)	mm (in)	1280 (50)	1565 (61.6)
Height (H)	mm (in)	1460 (57)	1860 (73.2)
Mass, dry	kg (lbs)	2950 (6500)	5270 (11618)
Mass, wet	kg (lbs)	3135 (6910)	5610 (12368)
Engine main data			
No. of cylinders		12	8
Bore/Stroke	mm (in)	135/165 (5.3/6.2)	170/210 (6.7/8.3)
Displacement/cyl.	l (cu in)	2.23 (136)	4.77 (291)
Displacement, total	l (cu in)	26.8 (1633)	38.1 (2327)

1) EU IIIA type approved, EU IIIA certificate available

2) For rail specific usage please contact your local partner.

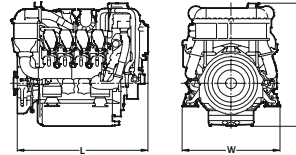
783 KW – 1200 KW
(1050 BHP – 1609 BHP)

Dimensions: Engines with standard equipment

16V 2000 S96 ²⁾		8V 4000 R43L	
Rated power	kW (bhp)	1163 (1560)	1200 (1609)
Speed	rpm	2100	1800
Exhaust emissions		Emission optimized w/o certificate	EU Stage IIIA compliant ¹⁾ / UIC IIIA
Fuel consumption at rated power	g/kWh	209	206
	l/h (gal/h)	–	297.8 (78.7)
at best point	g/kWh	195	194
Engines – dimensions & masses			
Length (L)	mm (in)	2370 (94)	2000 (78.7)
Width (W)	mm (in)	1280 (50)	1565 (61.6)
Height (H)	mm (in)	1480 (58)	1860 (73.2)
Mass, dry	kg (lbs)	3350 (7385)	5270 (11618)
Mass, wet	kg (lbs)	3600 (3935)	5610 (12368)
Engine main data			
No. of cylinders		16	8
Bore/Stroke	mm (in)	135/165 (5.3/6.2)	170/210 (6.7/8.3)
Displacement/cyl.	l (cu in)	2.23 (136)	4.77 (291)
Displacement, total	l (cu in)	35.7 (2177)	38.1 (2327)

Engines

FOR PUSH-PULL TRAINS
AND LOCOMOTIVES

- Well differentiated choice of engines spanning wide range of power outputs
- High power-to-weight ratios for lightweight trains

Engine model		12V 4000 R43	12V 4000 R43L
Rated power	kW (bhp)	1500 (2012)	1800 (2414)
Speed	rpm	1800	1800
Exhaust emissions		EU Stage IIIA compliant ¹⁾ / UIC IIIA	EU Stage IIIA compliant ¹⁾ / UIC IIIA
Fuel consumption at rated power	g/kWh	205	210
	l/h (gal/h)	370.5 (97.9)	455.4 (120.3)
at best point	g/kWh	192	190
Engines – dimensions & masses			
Length (L)	mm (in)	2386 (93.9)	2386 (93.9)
Width (W)	mm (in)	1562 (61.5)	1562 (61.5)
Height (H)	mm (in)	2015 (79.3)	2015 (79.3)
Mass, dry	kg (lbs)	6613 (14579)	6613 (14579)
Mass, wet	kg (lbs)	7080 (15609)	7080 (15609)
Engine main data			
No. of cylinders		12	12
Bore/Stroke	mm (in)	170/210 (6.7/8.3)	170/210 (6.7/8.3)
Displacement/cyl.	l (cu in)	4.77 (291)	4.77 (291)
Displacement, total	l (cu in)	57.2 (3491)	57.2 (3491)

1) EU IIIA type approved, EU IIIA certificate available

1500 KW – 1800 KW
(2012 BHP – 2414 BHP)

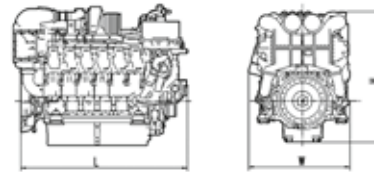

Dimensions: Engines with standard equipment

Engines

FOR PUSH-PULL TRAINS
AND LOCOMOTIVES

- Well differentiated choice of engines spanning wide range of power outputs
- High power-to-weight ratios for lightweight trains
- Meeting emissions regulations EU Stage IIIB

Engine model		12V 4000 R64	12V 4000 R84
Rated power	kW (bhp)	1500 (2012)	1800 (2414)
Speed	rpm	1800	1800
Exhaust emissions		EU Stage IIIB	EU Stage IIIB
Fuel consumption			
at rated power	g/kWh	203	202
	l/h (gal/h)	366.9 (96.9)	438.1 (115.7)
at best point	g/kWh	193	193
Engines – dimensions & masses			
Length (L)	mm (in)	2670 (105.1)	2670 (105.1)
Width (W)	mm (in)	1696 (66.8)	1696 (66.8)
Height (H)	mm (in)	2001 (78.8)	2001 (78.8)
Mass, dry	kg (lbs)	7700 (16976)	7700 (16976)
Mass, wet	kg (lbs)	8200 (18078)	8200 (18078)
Engine main data			
No. of cylinders		12	12
Bore/Stroke	mm (in)	170/210 (6.7/8.3)	170/210 (6.7/8.3)
Displacement/cyl.	l (cu in)	4.77 (291)	4.77 (291)
Displacement, total	l (cu in)	57.2 (3491)	57.2 (3491)

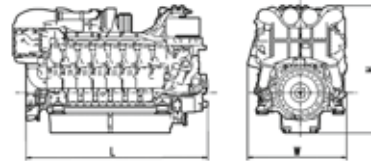
1500 KW – 1800 KW
(2012 BHP – 2414 BHP)

Dimensions: Engines with standard equipment

12V 4000 R54	
Rated power	1800 (2414)
Speed	1800
Exhaust emissions	EPA Tier 3
Fuel consumption	
at rated power	199
	431.6 (114.0)
at best point	195
Length (L)	2670 (105.1)
Width (W)	1696 (66.8)
Height (H)	2001 (78.8)
Mass, dry	7700 (16976)
Mass, wet	8200 (18078)
No. of cylinders	12
Bore/Stroke	170/210 (6.7/8.3)
Displacement/cyl.	4.77 (291)
Displacement, total	57.2 (3491)

Engines

FOR PUSH-PULL TRAINS
AND LOCOMOTIVES

- Cutting-edge technology with built-in potential
- Uniquely low emissions and consumption
- Market leader in its class for European diesel locomotives

Engine model		16V 4000 R43R	16V 4000 R43
Rated power	kW (bhp)	2000 (2682)	2200 (2950)
Speed	rpm	1800	1800
Exhaust emissions		EU Stage IIIA compliant ¹⁾ / UIC IIIA	EU Stage IIIA compliant ¹⁾ / UIC IIIA
Fuel consumption			
at rated power	g/kWh	207	206
	l/h (gal/h)	498.8 (131.8)	546.0 (144.3)
at best point	g/kWh	196	196
Engines – dimensions & masses			
Length (L)	mm (in)	2865 (112.8)	2865 (112.8)
Width (W)	mm (in)	1562 (61.5)	1562 (61.5)
Height (H)	mm (in)	2015 (79.3)	2015 (79.3)
Mass, dry	kg (lbs)	7930 (17483)	7930 (17483)
Mass, wet	kg (lbs)	8510 (18761)	8510 (18761)
Engine main data			
No. of cylinders		16	16
Bore/Stroke	mm (in)	170/210 (6.7/8.3)	170/210 (6.7/8.3)
Displacement/cyl.	l (cu in)	4.77 (291)	4.77 (291)
Displacement, total	l (cu in)	76.3 (4654)	76.3 (4654)

1) EU IIIA type approved, EU IIIA certificate available

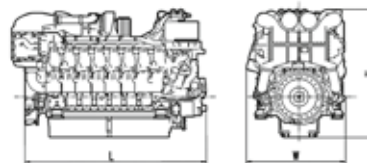
2000 KW – 2400 KW
(2682 BHP – 3218 BHP)

Dimensions: Engines with standard equipment

16V 4000 R43L	
Rated power	2400 (3218)
Speed	1800
Exhaust emissions	EU Stage IIIA compliant ¹⁾ / UIC IIIA
Fuel consumption	
at rated power	205
	592.8 (156.6)
at best point	196
Engines – dimensions & masses	
Length (L)	2865 (112.8)
Width (W)	1562 (61.5)
Height (H)	2015 (79.3)
Mass, dry	7930 (17483)
Mass, wet	8510 (18761)
Engine main data	
No. of cylinders	16
Bore/Stroke	170/210 (6.7/8.3)
Displacement/cyl.	4.77 (291)
Displacement, total	76.3 (4654)

Engines

FOR PUSH-PULL TRAINS
AND LOCOMOTIVES

- Cutting-edge technology with built-in potential
- Uniquely low emissions and low consumption
- Meeting emissions regulations EU Stage IIIB

Engine model		16V 4000 R64	16V 4000 R74
Rated power	kW (bhp)	2000 (2682)	2200 (2950)
Speed	rpm	1800	1800
Exhaust emissions		EU Stage IIIB	EU Stage IIIB
Fuel consumption			
at rated power	g/kWh	201	202
	l/h (gal/h)	484.3 (128.0)	535.4 (141.5)
at best point	g/kWh	190	190
Engines - dimensions & masses			
Length (L)	mm (in)	3140 (123.6)	3140 (123.6)
Width (W)	mm (in)	1696 (66.8)	1696 (66.8)
Height (H)	mm (in)	2001 (78.8)	2001 (78.8)
Mass, dry	kg (lbs)	9050 (19952)	9050 (19952)
Mass, wet	kg (lbs)	9670 (21319)	9670 (21319)
Engine main data			
No. of cylinders		16	16
Bore/Stroke	mm (in)	170/210 (6.7/8.3)	170/210 (6.7/8.3)
Displacement/cyl.	l (cu in)	4.77 (291)	4.77 (291)
Displacement, total	l (cu in)	76.3 (4654)	76.3 (4654)

1) EU IIIA type approved, EU IIIA certificate available

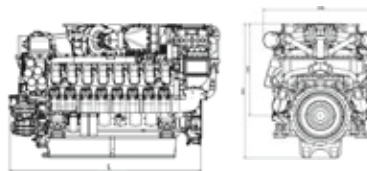
2000 KW - 2400 KW
(2682 BHP - 3218 BHP)

Dimensions: Engines with standard equipment

16V 4000 R84	16V 4000 R54
2400 (3218)	2400 (3218)
1800	1800
EU Stage IIIB	EPA Tier 3
199	199
575.4 (152.0)	575.4 (152.0)
190	195
3140 (123.6)	3140 (123.6)
1696 (66.8)	1696 (66.8)
2001 (78.8)	2001 (78.8)
9050 (19952)	9050 (19952)
9670 (21319)	9670 (21319)
16	16
170/210 (6.7/8.3)	170/210 (6.7/8.3)
4.77 (291)	4.77 (291)
76.3 (4654)	76.3 (4654)

Engines

FOR PUSH-PULL TRAINS
AND LOCOMOTIVES

- Outstanding power density. Unbeaten power-to-weight ratio
- Up to 3,300 kW for 4-axle locomotives and 6-axle locomotives

Engine model		20V 4000 R43	20V 4000 R63R
Rated power	kW (bhp)	2700 (3621)	2700 (3621)
Speed	rpm	1800	1800
Exhaust emissions		EU Stage IIIA compliant ¹⁾ / UIC IIIA	EU Stage IIIA compliant/ UIC IIIA
Fuel consumption at rated power	g/kWh	208	204
	l/h (gal/h)	676.6 (178.8)	663.6 (175.3)
at best point	g/kWh	194	194
Engines – dimensions & masses			
Length (L)	mm (in)	3335 (131.3)	3592 (141.4)
Width (W)	mm (in)	1562 (61.5)	1570 (61.8)
Height (H)	mm (in)	2015 (79.3)	2015 (79.3)
Mass, dry	kg (lbs)	9860 (21738)	10400 (22928)
Mass, wet	kg (lbs)	10520 (23193)	11070 (24405)
Engine main data			
No. of cylinders		20	20
Bore/Stroke	mm (in)	170/210 (6.7/8.3)	170/210 (6.7/8.3)
Displacement/cyl.	l (cu in)	4.77 (291)	4.77 (291)
Displacement, total	l (cu in)	95.3 (5818)	95.3 (5818)

1) EU IIIA type approved, EU IIIA certificate available

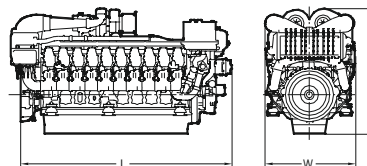
2700 KW – 3300 KW
(3621 BHP – 4425 BHP)

Dimensions: Engines with standard equipment

20V 4000 R43L	20V 4000 R63	20V 4000 R63L
3000 (4023)	3000 (4023)	3300 (4425)
1800	1800	1800
EU Stage IIIA compliant ¹⁾ / UIC IIIA	EU Stage IIIA compliant/ UIC IIIA	EU Stage IIIA compliant/ UIC IIIA
210	206	206
759.0 (200.5)	744.6 (196.7)	819.0 (216.4)
194	197	195
Engines – dimensions & masses		
3335 (131.3)	3592 (141.4)	3592 (141.4)
1562 (61.5)	1570 (61.8)	1570 (61.8)
2015 (79.3)	2015 (79.3)	2015 (79.3)
9860 (21738)	10400 (22928)	10400 (22928)
10520 (23193)	11070 (24405)	11070 (24405)
Engine main data		
20	20	20
170/210 (6.7/8.3)	170/210 (6.7/8.3)	170/210 (6.7/8.3)
4.77 (291)	4.77 (291)	4.77 (291)
95.3 (5818)	95.3 (5818)	95.3 (5818)

References

DIESEL ENGINES AND POWERPACKS
IN RAILCARS/PUSH-PULL
TRAINS AND LOCOMOTIVES

High-Speed-Trains and Locomotives

Deutsche Bahn
V290
1 x 1000 kW



CNR
Dalian DL class
1 x 2700 kW



Siemens ER 20D
„EURORUNNER“
1 x 2000 kW



CZ
Loco 2M62
2 x 2200 kW



Siemens/Alstom
BB 475000
1 x 2000 kW



©Siemens

Railcars



Alstom
Lint 54 PowerPack
1-4 x 390 kW
(depending on class)



PESA
Link PowerPack
2 x 390 kW



Hitachi
IEP PowerPack
1-5 x 700 kW
(depending on class)



Bombardier
Turbo Star PowerPack
2 x 390 kW



Rotem
Class 22000 PowerPack
3 x 360 kW

References

DIESEL ENGINES AND
POWERPACKS FOR
SPECIAL-PURPOSE RAIL VEHICLES

- Individual traction system solutions
- Flexibility in design and installation

Remote-controlled shunter



Fire fighting and rescue train

Auxiliary locomotive for
tunnel operations

Railroad inspection vehicle



Further applications with MTU system solutions are e.g.:

- Locomotives for underground railways
- Mountain railways

- Emissions optimized engines for tunnel operations with particle filter/exhaust catalyst



Rotary Snow-Plow

Grinding train



Track layer



Rail crane



Overhead line inspection railcar



Repowering

WITH DIESEL ENGINES

For economical reasons, many railway companies and locomotive operators have decided to repower older locomotives and rail cars which are in good general condition with modern diesel engines. Due to their high technical standards, MTU engines fulfill all technical criteria for repowering projects:

- Economical alternative to new procurement
- Reduced investment costs
- Increased availability equal to that of a new vehicle
- Individual solutions to suit existing system interfaces



We are your competent partner for a successful repowering project and offer everything you require:

- Active support provided by a professional engineering service during all phases of a repowering project
- Design and realisation of the traction plant
- Engines adaptable to existing parameters
- Reliable and sturdy engines with low fuel and lube oil consumption rates
- Long maintenance intervals and low life-cycle costs
- Compact dimensions for easy installation in existing engine rooms
- Low installation and maintenance effort
- The accessories incorporate clearly defined interfaces and are mounted to the engine in such a manner as to be easily accessible for maintenance operations
- Excellent power-to-weight ratios permit installation of higher power ratings without exceeding permissible axle loads
- Qualified support by our Product Support organisation
- Meet all applicable exhaust gas and noise emissions limit values



PowerControl Automation

LIKE A DIGITAL NERVOUS SYSTEM THAT DOESN'T MISS A THING.

Visionary, and packed full of benefits: The MTU PowerControl Automation system is our innovative high-end technology for rolling stock, i.e. railcars. MTU PowerControl Automation optimizes the control, regulation and monitoring of the entire drive system. The modular system ensures that the drive system can be adapted to the complex operating conditions that occur in railway applications.

PowerControl Automation enables:

- Simple integration with new or – in the case of conversions – existing vehicle control systems
- Flexible adjustment capability to suit the vehicle, its components and project-specific requirements
- Automatic power adjustment or, if required, engine shutdown by the integrated safety system as well as all other required monitoring and safety functions
- The built-in automatic power management system ensures that maximum available drive power is always to hand
- Maximum uptime in the tough operating conditions that confront rail operators, including extremes of heat, cold, airborne dust and water spray



The new PowerPack generation therefore offers you:

- High power efficiency
- Minimum fuel consumption
- Minimum exhaust emissions that are significantly below statutory requirements (e.g. valid EU Stage IIIA and EU Stage IIIB)
- Flexible, standardized interface solutions

An optimum environment for diagnosis and maintenance:

- Provision of operating and diagnostic data for maximum drive system uptime
- Unlocking the full potential of MTU systems using our digital solutions MTU Go! Act and MTU Go! Manage, for example via
 - proactive failure prevention
 - fast service support through efficient communication tools
 - intelligent troubleshooting
 - optimized maintenance planning

LIKE A DIGITAL NERVOUS SYSTEM THAT DOESN'T MISS A THING.

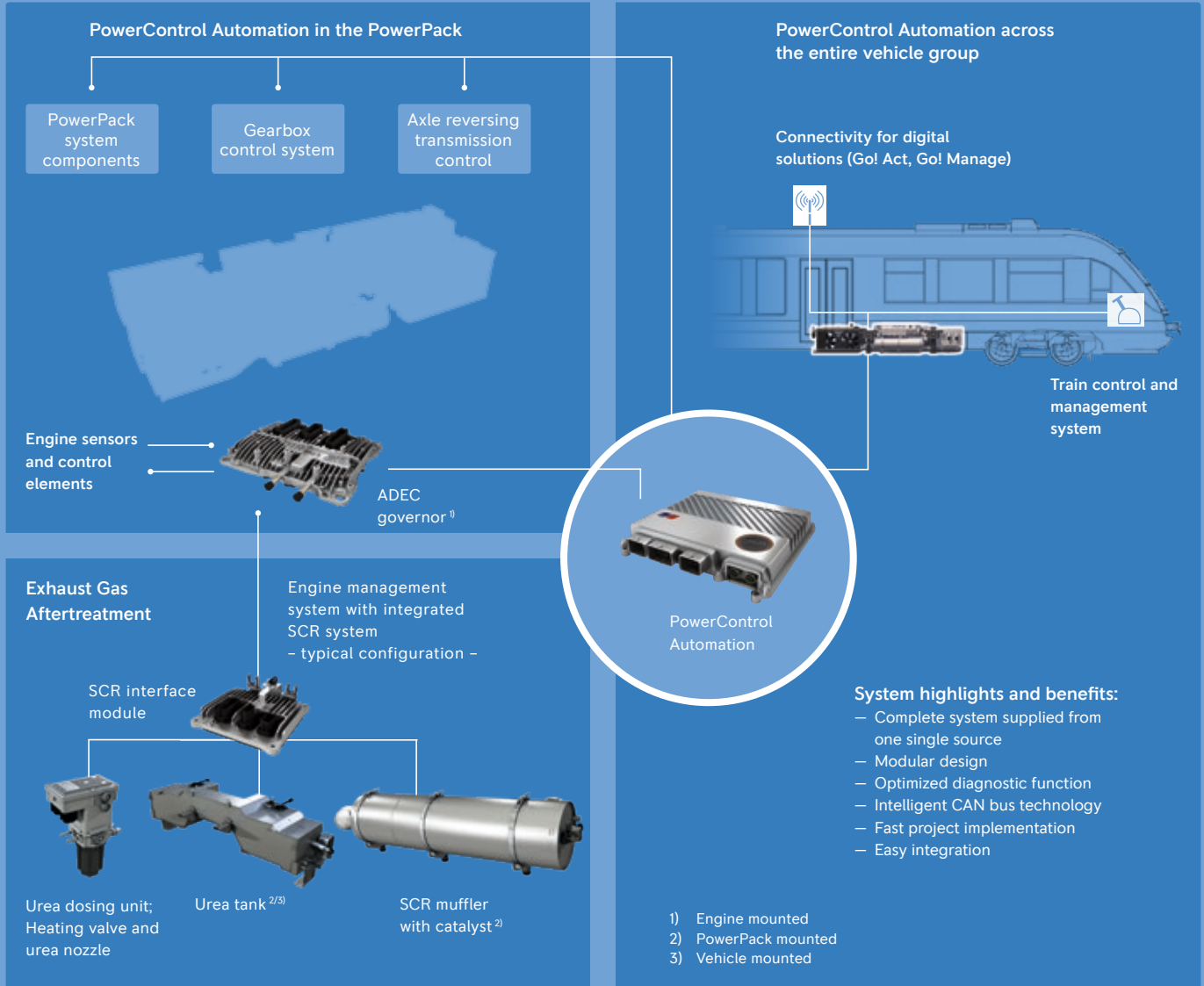

Automation

SAFEMON FOR POWERPACKS:
THE INTEGRATED SAFETY CENTER

For vehicle manufacturers and railway operators, the safety of their passengers has top priority. With the SafeMon (Safety Monitor) we help you to reduce operational risks – and to achieve the set safety objectives even faster and easier.

SafeMon consists of a certified monitoring unit for safety-relevant functions as well as the associated safety- and approval-related documentation. The functions that control these signals fulfill the level of safety specified by the operator, rated according to Safety Integrity Level (SIL). This specifies, that in the event of faulty or defective components, safety-relevant procedures, such as braking, coupling or uncoupling, are guaranteed just as before. As a result, consequential damage due to unwanted traction or overspeed is prevented.

We develop safety technology in-house - which therefore is perfectly oriented to the MTU PowerPack. SafeMon is integrated directly in the power system via a simple hardware interface, existing vehicles can also be readily upgraded. Manufacturers of rail vehicles receive a complete package that has already been subjected to all hazard- and risk assessments and certified for the safety level that they require; we prepare the corresponding documentation. The separate safety certificate can be included directly in the report for the independent assessment body. This considerably simplifies the approval process for the complete vehicle.

With SafeMon you are safely en route at all times:

- Complete safety concept for the entire power train
- Control of all safety functions according to the required safety level – completely documented and already examined by external bodies
- Complete power system from a single source, certified according to the European Standard for Proof of Safety (EN 50129)
- We supply the associated documentation and thereby simplify the approval process

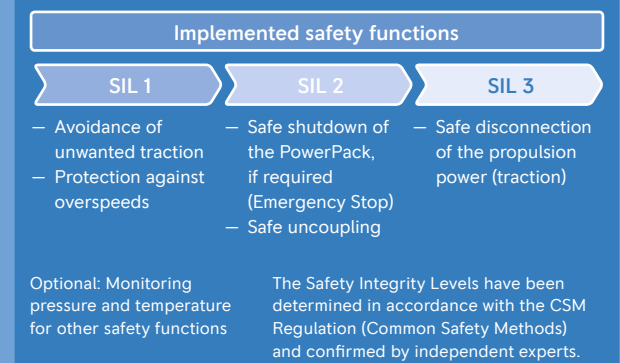
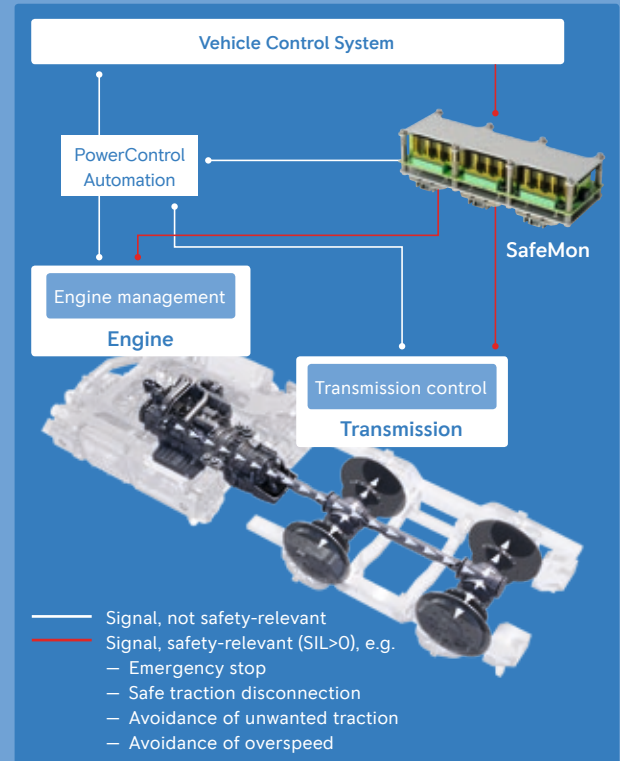

Automation

POWERLINE
FOR SERIES 4000

powerline – our automation system for train drive units – represents a step into a whole new future of technology for rail vehicles. Even with only the basic components ADEC, POM and PAU, the powerline automation system makes the integration of the engine into the locomotive a simple process. POM, like ADEC, is an electronic module mounted permanently to the engine. Control, regulation and monitoring are all part of the package that we deliver. With the help of optimized interface technology, the engine is quick and easy to install.

ADEC engine control systems

The engine control system ADEC (Advanced Diesel Engine Control) for Series 4000 R03/R04 is a system that has been developed and produced by us specifically for use with the very latest high-performance diesel engine technology – designed not only for full control of the Common Rail technology in the Series 4000, but above all for the management of frequent extreme loads and sudden load changes, which can be overcome effortlessly and smoothly using this system.

The most important features at a glance:

- Component mounted on and wired into the engine
- Integrated control and monitoring system
- Fuel-optimized output regulation
- Integrated safety and self-test system
- Data bus interface



ADEC - Engine Management

POM (Power Output Module) for Series 4000 R03/R04

Module with actuating function for the starter motor and alternator, with the following features:

- Component mounted on the engine
- Starter relay and other conventional power routing not required
- Optimization of start-up process; starter motor monitoring with engaging function
- Alternator function monitoring
- Line break and short circuit monitoring
- Battery voltage monitoring with start-up intervention plus status indication and error report function
- ADEC and POM linked via CAN data bus
- Fully automated start-up control with ADEC

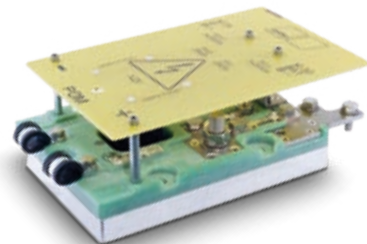

POM - Interface Module

Automation

POWERLINE FOR SERIES 4000

**powerline for new locomotives or repowering
with Series 4000****PAU Engine (Power Automation Unit)**

Module for the monitoring, control and system integration of peripheral engine components, with the following features:

- Stand-alone component with (redundant) CAN-open interface to vehicle control system
- Transfer of all engine-related operational data including diagnostics to the vehicle control system
- Additional monitoring and control of peripheral engine systems
 - Coolant level monitoring
 - Fuel pump actuation
 - Air filter monitoring
 - Integrated safety functions
 - Data output for fuel consumption indicator
 - Ethernet diagnosis interface (e.g. service laptop)
 - Fault ring buffer
 - Cooling fan regulation
 - Preheating control



PAU - Engine

POWERLINE FOR SERIES 4000 R03/R04

ADEC = Advanced Diesel
Engine Control
PAU = Power Automation Unit
POM = Power Output Module

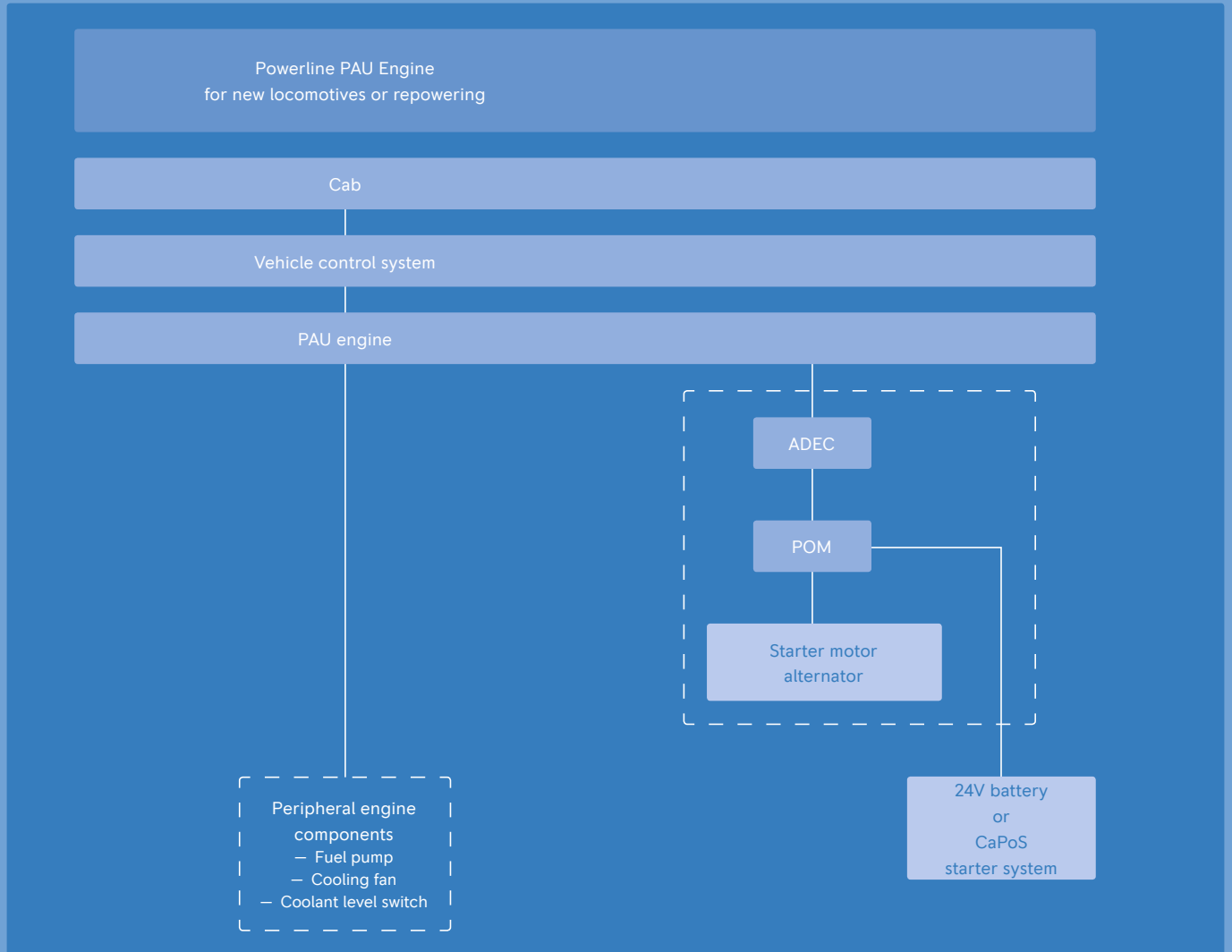
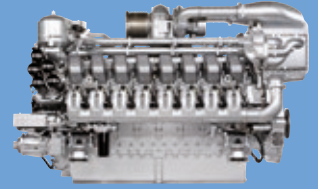

Automation

CAPOS – CAPACITOR POWER SYSTEM
FOR SERIES 4000**Innovation right from the start.**

CaPoS is an innovative UltraCap voltage supply system which obviates the need for conventional starter batteries in railroad applications.

CaPoS uses capacitor technology to optimize startup behavior. The number of UltraCap modules used is dependent on the motor type/power system and its breakaway torque. CaPoS may be used autonomously or in conjunction with the powerline automation system.

The most important features at a glance:

- Autonomous and modular construction
- Maintenance-free system
- Significant reductions in weight and volume compared with conventional starter batteries
- Optimized cold-starting properties
- Low life-cycle-costs
- No voltage dip in the onboard network during the start procedure
- Onboard voltage of 16V – 154V possible
- Wired-up complete system
- CAN interface with powerline



CaPoS with powerline - Sample for the 12V 4000

CAPOS WITH POWERLINE

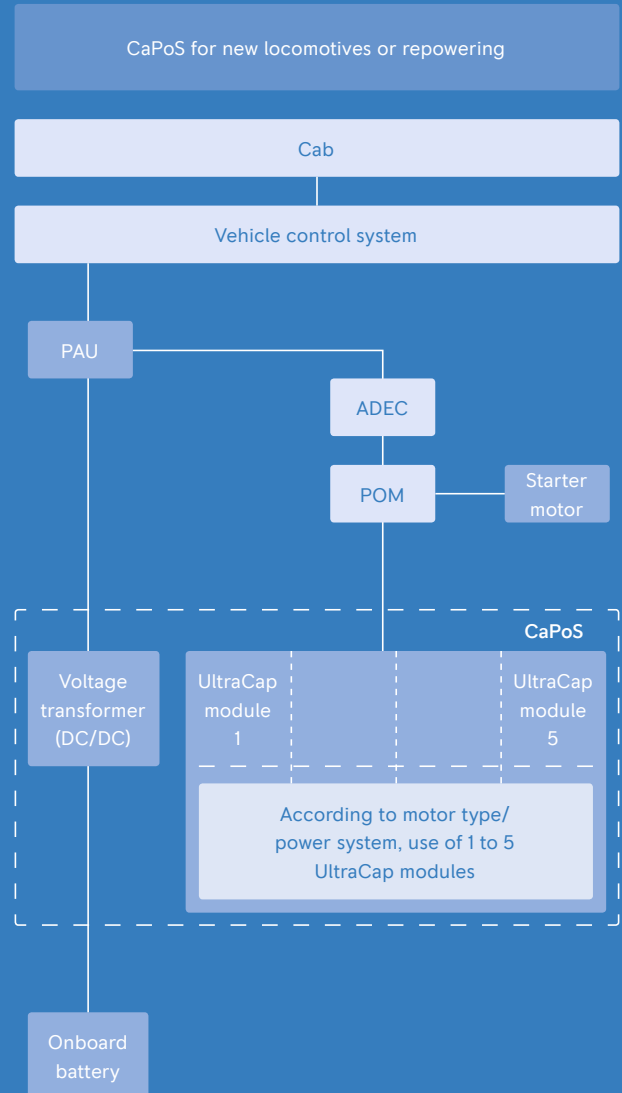

CAPOS SMART EDITION

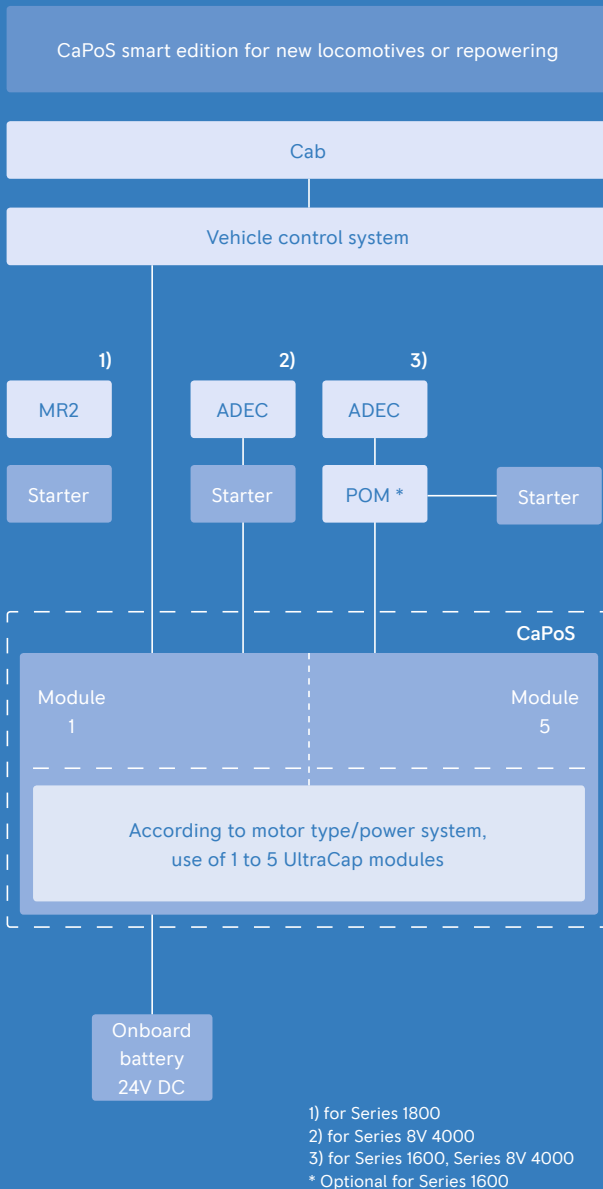

Automation

CAPOS SMART EDITION –
CAPACITOR POWER SYSTEM FOR
SERIES 1600, 1800 AND 4000**Reliable power right from the start.**

CaPoS smart edition was especially developed for heavy and duty applications and provides the high energy required by the 24V DC starters during the starting sequence.

CaPoS smart edition uses capacitor technology to optimize start-up behavior. The number of modules used is dependent on the motor type/power system and its breakaway torque.

The most important features at a glance:

- Autonomous and modular construction
- Maintenance-free system
- Significant reductions in weight and volume compared with conventional starter batteries
- Optimized cold-starting capabilities
- Low life-cycle-costs
- No voltage dip in the onboard network during the start procedure
- Onboard voltage of 24V DC
- Integrated self-monitoring system with interface to vehicle control system
- Integrated DC-/DC converter for automatical recharging
- IP66 protection



CaPoS smart edition – Sample for the 12V 1600

Complete lifecycle solutions.

ENSURE A LONG, RELIABLE LIFE.

As your equipment ages, its needs—and yours—change. Our full portfolio of service solutions wrap around your investment, providing 360 degrees of customized support, for optimal value at every stage of life.

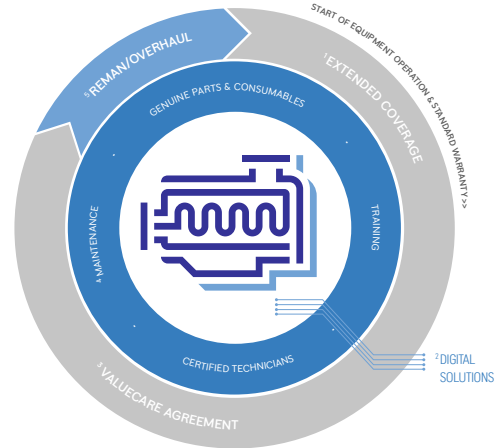

- 1 Avoid the unexpected with added protection beyond the standard warranty.
- 2 Make better decisions faster with data-enhanced tools.
- 3 Maximize availability and optimize lifecycle costs with a ValueCare Agreement.
- 4 Improve system performance and extend equipment life with on-demand support.
- 5 Keep a good thing going with factory reman/rebuild solutions.

Complete lifecycle solutions.

RELY ON OUR EXPERTISE.

To give your equipment a long and productive life, choose a partner you can trust. Only factory-certified technicians know how to get the job done right using proven service methods, factory-specified maintenance schedules and genuine OEM parts.

From preventive maintenance to complete overhaul, we are your true lifecycle partner. Whatever level of support you need, our global network of factory-trained professionals knows all about your equipment and is ready to help you maximize performance and minimize lifecycle costs.

Never compromise

MTU engines and systems are built to last with legendary high standards. When it's time for service, don't settle for anything less. Protect the life of your equipment with professional certified service technicians and genuine OEM parts and consumables—the only options that live up to our standards for craftsmanship, quality and performance. To get the most from your equipment, there are no shortcuts. For maximum reliability, performance and uptime, choose a name you can trust.

If you need us a little:

On-Demand Support—including professional inspections and preventive maintenance recommendations from us—we help you to identify and address problems early, save on repairs or unexpected downtime, and optimize your equipment's performance and longevity. Inspections include visual assessment, test run and leak check, on-site oil and coolant analysis, diagnostic evaluation and reporting.

If you need us a lot:

ValueCare Agreements make it easy to keep your business running smoothly and reduce total cost of ownership by maximizing uptime, optimizing lifecycle costs and helping you avoid equipment-related business disruptions through preventive maintenance.



ValueCare Agreements

FOCUS ON YOUR OPERATIONS. LEAVE THE REST TO US.

Service solutions designed around your priorities

ValueCare Agreements make it easy to optimize lifecycle costs, maximize uptime and devote more time and resources to your core business, with tailored solutions to move your business forward.

Gold

Maximize operational uptime

- Operational uptime commitment to meet or exceed your availability targets
- Regular supervision by local service partner (e.g. monitoring of parts stock,
- 24/7 emergency assistance with on-site support
- Monthly reports, including availability and average repair times
- Asset health monitoring
- Annual performance meetings and trend analysis with us to address technical updates, engine fleet data, operational optimization and more

Gold also includes all benefits of Silver & Bronze levels



Silver

Eliminate unexpected maintenance costs

- Proactive maintenance planning, troubleshooting and remote engine health monitoring
- Fixed pricing per operating hour for maintenance and repairs
- Key corrective maintenance components always in-stock at our main warehouses
- 24/7 standby service with remote technical support
- Quarterly reports, including reliability analysis (mean time between failure)

Silver also includes all benefits of Bronze level







Bronze

Ensure parts availability and price stability

- Digital connectivity (Go! Connect) and platform access (Go! Manage)
- Automated delivery of parts (preventive) at a predefined rate based on operating hours
- Preventive maintenance labor options to fit your business needs
- Dedicated support for technical issues
- Quarterly reporting of completed and upcoming maintenance and costs
- Annual on-site engine health check by our technician



ValueCare Agreements help you:

-  Increase operational uptime
-  Guarantee parts availability and service quality
-  Predict equipment-related costs
-  Optimize maintenance planning
-  Connect to us, 24/7

Digital Solutions

THE FUTURE IS DIGITAL.

Fueled by your system's data—and supplemented with our exclusive expertise, smart analytics and extensive database—digital solutions magnify the power of your investment.

From proactive failure prevention and intelligent troubleshooting to instant failure support and smart maintenance planning, digital solutions unlock the full potential of your MTU system.

 **Go! Act**
Service in your pocket

Designed to support on-site operators, Go! Act:

- Receives push notification of failure codes from connected assets
- Provides crew members with vital information about failure codes
- Supports event reporting with convenient photo capture functionality
- Enables direct communication with fleet managers or our Customer Assistance Center

 **Go! Manage**
Monitor your fleet

Built for fleet managers, Go! Manage:

- Provides a live overview of fleet, asset and engine conditions
- Displays active and closed alarms
- Enables interaction and communication with on-site staff via Go! Act
- Shows maintenance schedule, with completed tasks clearly marked
- Supports remote troubleshooting via multigraph

Remanufactured Products

EXCHANGE AND SAVE.

Factory remanufactured products deliver the same high standards of performance, service life and quality as new products, along with identical warranty coverage—at a fraction of the cost. And with design and model-related updates, they also feature similar technological advancements. Developed by R&D engineers, the remanufacturing process saves you time and money, while benefiting the environment through the reuse of materials. To help you work efficiently, a wide range of remanufactured parts, engines and systems are available worldwide.

Reduce lifecycle costs.

As you evaluate your long-term power needs, you must consider a variety of factors. Factory remanufactured products are a smart solution, helping you reduce the total lifecycle cost of your equipment.

Save time.

Factory remanufactured products put your equipment back to work faster than an overhaul, which reduces downtime, service time and indirect costs such as storage.

Maintain standards.

All products are remanufactured to our strict standards by our certified technicians at our regional reman centers. Only we can remanufacture our parts, engines or systems to original factory specifications.

Protect the environment.

Since remanufacturing is an efficient use of resources and energy, factory remanufactured products benefit the environment as well.

Service Network

LOCAL SUPPORT.
WORLDWIDE.

The most important part of your power system isn't a part at all—it's your local service team. With more than 1,200 service locations worldwide—backed by regional Parts Logistics Centers in Europe, Asia and America—you can count on responsive support by expert technicians, wherever work takes you. To find your local service partner, visit www.mtu-solutions.com.

Always on call, 24/7

Whether it's connecting you with a local service partner or assigning an urgent problem to a dedicated team of our experts, we're ready to assist you—wherever you are, whatever you need.

Europe, Middle East, Africa +49 7541 90-77777

Asia/Pacific +65 6860 9669





North and Latin America +1 248 560 8888

info@ps.rolls-royce.com



Series and emissions qualification





ENGINES OVERVIEW



Model	UIC IIIA	EU Stage IIIA compliant	EU Stage IIIB certified	US EPA Tier3	Fuel cons. opt. w/o certificate
MTU PowerPacks for Railcars Series 1800 		■	■	■	
Series 1600 			■		
MTU Engines for Push-Pull Trains and Locomotives Series 2000 					■
MTU Engines for Railcar Trainsets, Push-Pull Trains and Locomotives Series 4000 8V/12V/16V/20V 4000 R43 ¹⁾ 20V 4000 R63 12V/16V 4000 R54 12V/16V 4000 R64/74/84 	■ ■ ■ ■	■ ■ ■ ■	■ ■ ■ ■	■ ■ ■ ■	■ ■ ■ ■

1) EU IIIA type approved, EU IIIA certificate available

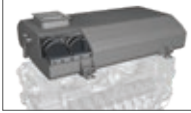

Key technologies for the reduction of emission
and consumption

ENGINE TECHNOLOGY

Engine model	Exhaust Gas Aftertreatment		
	SCR	DPF	DOC
Railcars Series 1800 	■		
Series 1600 	■		
Locomotives Series 2000 			
Series 4000 		■	■

Exhaust Gas Aftertreatment	
Selective Catalytic Reduction (SCR) 	
Diesel Particulate Filter (DPF) 	
Diesel Oxidation Catalyst (DOC) 	

Internal Emission Technology		
EGR	2st Turbocharging	Advanced CR
		■
■	■	■
■	■	■

Internal Emission Technology	
Exhaust Gas Recirculation (EGR) 	
Two-Stage Turbocharging 	
Advanced Common Rail Fuel Injection 	

EXHAUST EMISSIONS

Many countries have implemented environmental legislation to protect people from consequences of polluted air. For this reason an increasing number of countries regulate emissions from specific mobile and stationary sources.

Emission standards may apply internationally, nationally and/or for specific areas. The enforcement of an emission legislation may depend for example on the area where the equipment is used and the way it is operated. The emission legislations may be categorized by power range and/or cylinder capacity.

Emission legislations generally require a certificate which states compliance. Stationary applications may require on-site approvals (on-site emission test) depending on the particular emission legislation.

Please find as follows examples of emission standards which apply to the rail industry. For details please consult the applicable legislation and/or permitting authority.

- European emission legislation differentiates between locomotive and railcar applications.
- US emission legislation differentiates between line-haul and switch-haul locomotive applications.
- US rail emission legislation is specific for ratings 750 kW and above. For ratings below 750 kW nonroad mobile machinery legislation applies.
- UIC (International railway association) emission standards may be applied when national legislations is not available.

Please note

That the engines and systems (only) comply with country or region specific emission requirements and have appropriate emission certification(s) which are explicitly stated in respective technical specifications. Any export/import/operation of the engine in countries or regions with different applicable emission law requirements is at the customers responsibility.

Samples for emission stages in rail industry:

EU Railcar

EU Rail Railcar > 130 kW

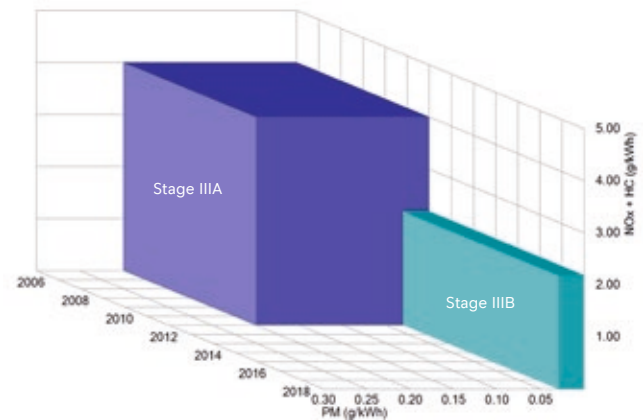

EU Locomotive

EU Rail Locomotives > 560 kW

