

PAST.
PRESENT.
FUTURE.

100

Shaping the rail industry for 100 years.

Rail

SOLUTION GUIDE

Edition 1/24, valid from 08/2024



A Rolls-Royce
solution



CONTENTS

Pioneering the power that matters	04	References of diesel engines and PowerPacks for special-purpose rail vehicles	42
General specifications	06	Repowering solutions	44
Engine designation	07	Automation solutions	46
Performance overview	08	Drive system control	
PowerPacks for roof and underfloor installation		Enhanced automation functions	
PowerPacks for railcars	10	Parts & service	50
Hybrid PowerPacks for railcars	12	<i>mtu</i> service solutions - a lifetime of value	
Applications	14	Extended coverage	
PowerPacks for railcars		<i>mtu</i> ValueCare Agreements	
Performance overview	22	Digital solutions	
System solutions and engines for engine room installation		Reman/overhaul solutions	
System solutions with Series 4000	24	Support services	
Applications	26	Emissions	60
Engines for push-pull trains and locomotives		Emission reduction solutions – certifications	
References of diesel engines and PowerPacks in railcars/push-pull trains and locomotives	40	Emission reduction solutions – technologies	
		HVO - Your fast track ticket to lower emissions	
		Exhaust emissions	
		Conversion table	69

PIONEERING THE POWER THAT MATTERS.

We at Rolls-Royce provide world-class power solutions and complete life-cycle support under our product and solution brand **mtu**. Fully utilizing the potential of digitalization and electrification, we strive to develop climate-neutral drive and power generation solutions that are even cleaner and smarter and thus provide answers to the challenges posed by climate change and the rapidly growing societal demands for energy and mobility. We deliver and service comprehensive, powerful and reliable systems, based on both gas and diesel engines, as well as electrified hybrid systems.

A solution provider

mtu systems power the strongest tugboats, the most modern yachts and the biggest land vehicles and provide energy for the world's most important mission-critical applications. With advanced solutions such as microgrids we integrate renewable energies and manage the power needs of our customers.

For over 110 years we have provided innovative solutions for our customers – meeting even the most demanding drive and power requirements. Our products and services span a wide range of applications and power needs, with both standard and customized options.

An expert in technology

mtu products are known for cutting-edge innovation and technological leadership. That same spirit of innovation inspires our sustainability efforts. Our focus is on developing and implementing system solutions that both maximize efficiency and reduce emissions – which in turn helps to reduce our impact on the environment.

A passionate and reliable partner

We at Rolls-Royce spend every day working together with our customers, to deliver engines, systems and complete life-cycle solutions that best fit their needs. We understand that each application is different and has its own specific demands. Our engineers embrace the challenge of finding the perfect solution for your unique power requirements. Every step of the way – from project planning, through design, delivery and commissioning; to the lifetime care of your equipment – we are dedicated to helping you get the most from your **mtu** investment.



1

2

3

1 ISO 9001

2 ISO 14001

3 UIC

GENERAL SPECIFICATIONS

Four-stroke diesel engine for traction

- Direct injection
- Liquid-cooled
- V or In-line configuration
- Suitable for mechanical, hydrodynamic, hydrostatic and electric power transmission

Power Definition

All power ratings are service standard power in accordance with ISO 3046 and UIC.

Ambient air pressure:	1000 mbar
Height above sea level:	100 m
Intake air temperature:	25 °C
Charge-air coolant temp.:	45 °C

Fuel consumption in accordance with DIN/ISO 3046

Exhaust emission standards

EU = EU Nonroad Directive 2016/1628
 EPA = US Regulation 40 CFR
 UIC = International Railway Association

Please note, specifications are subject to change without further notice. All dimensions are approximate, more detailed information is included within installation drawings.

For further information on our rail products please contact your distributor or visit: www.mtu-solutions.com

EXPLANATION OF THE ENGINE DESIGNATION

Series 1800, 1600, 2000, 4000 – Example

16 V 4000 R 4 3 L

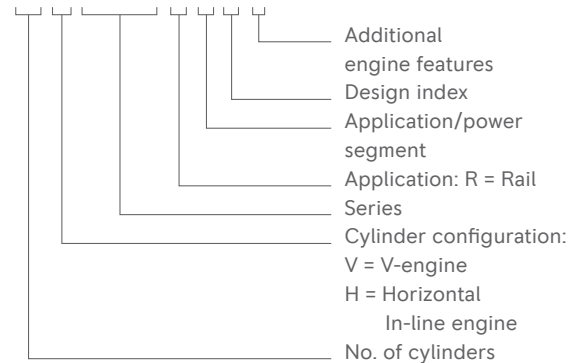

Additional engine features

Power uprated	L
Speed/power reduced	R
PowerPack	P

Performance overview

POWERPACKS

PowerPacks for roof and underfloor installation

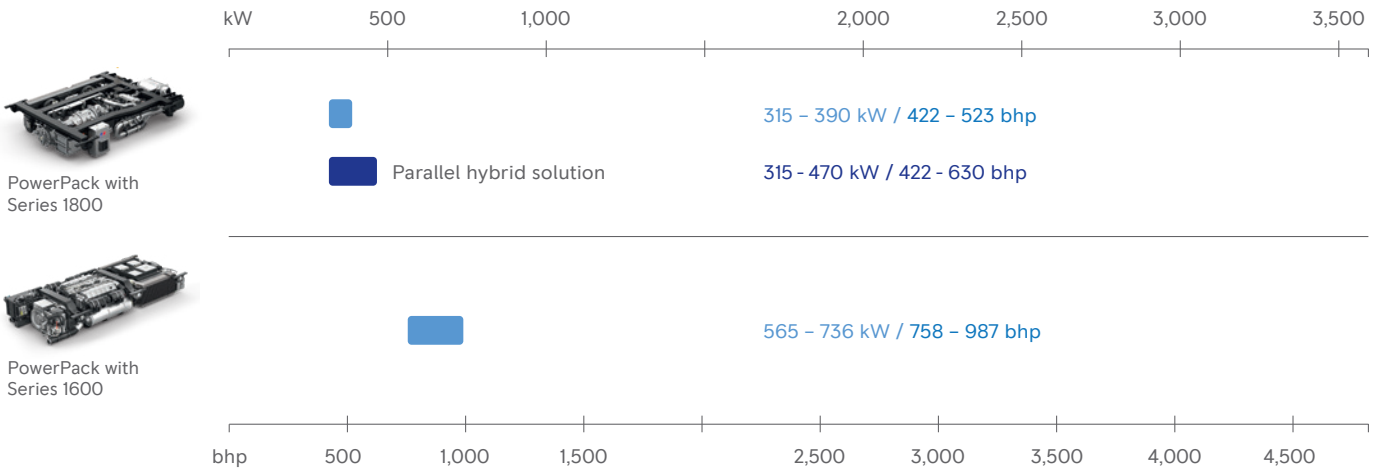

Drive solutions for railcars, push-pull trains and locomotives

POWERPACKS FOR RAILCARS

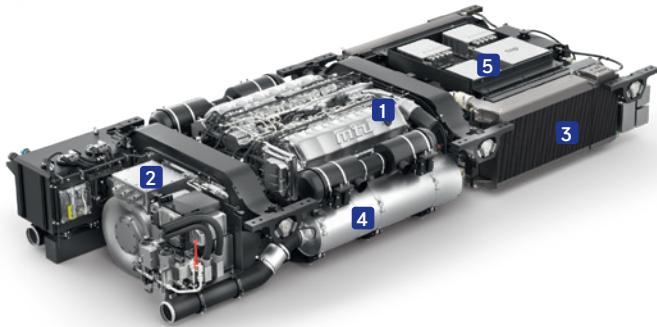

mtu PowerPack –
the highly compact, highly integrated solution.

Representation of a diesel-electric **mtu** PowerPack 12V 1600 with aftertreatment system (SCR, DPF and DOC). We have developed a series of individualized solutions involving a range of different frames and will use our extensive experience to find the appropriate solution.

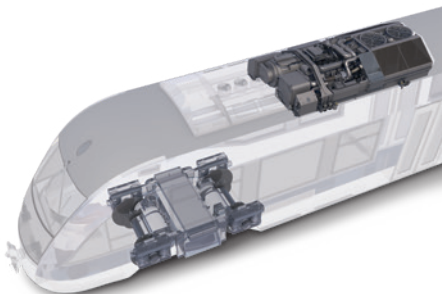

Roof mounting

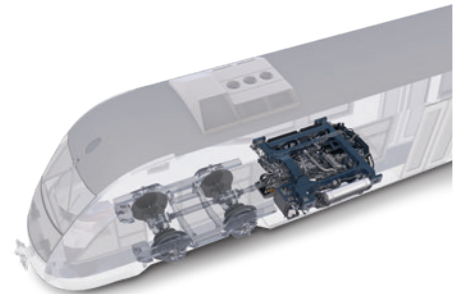

Underfloor mounting

Standard scope of supply

1 Engine	6H 1800 12V 1600
2 Power transmission	
Transmission	DM: ZF 6AP 2000R / ZF 6AP 2500RDH
Traction generator	Permanent magnet synchronous generator External excited synchronous generator Asynchronous generator
3 Cooling system	Underfloor or roof installation Hydraulic or electrical fan drive
4 Exhaust system	EU Stage IIIA compl. – exhaust silencer EU Stage IIIB compl. – SCR exhaust aftertreatment system EU Stage V – SCR plus DPF & DOC exhaust aftertreatment system

Additional scope of supply

5 On-board power generation	
Preheating	
CaPos smart edition	
Autom. oil replenishment	

Drive solutions for railcars, push-pull trains and locomotives

HYBRID POWERPACKS FOR RAILCARS

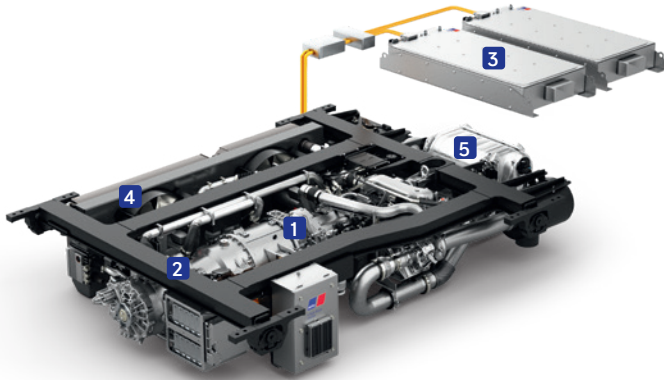

Hybrid PowerPack –
the next generation of railcar drive systems.

Representation of a Hybrid PowerPack 6H 1800 with two **mtu** EnergyPacks and with EU Stage V aftertreatment system (SCR, DPF and DOC). A proven hybrid drive system, ready for commercial operation: our modular platform offers customizable drive solutions that can be combined to ensure maximum efficiency, flexibility and sustainability.

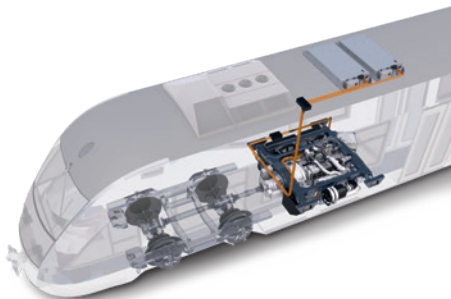

Roof mounting of **mtu** EnergyPacks

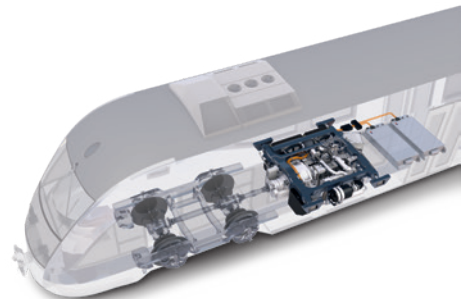

Underfloor mounting of **mtu** EnergyPacks

Standard scope of supply

1	Engine	6H 1800
2	Power transmission	
	Parallel hybrid	ZF 6 AP 2500R and mtu electrical drive
3	Battery system	34,4 kWh per battery
4	Cooling system	Underfloor installation, electrical fan drive
5	Exhaust system	EU Stage IIIA compl. – exhaust silencer
		EU Stage IIIB compl. – SCR exhaust aftertreatment system
		EU Stage V – SCR plus DPF & DOC exhaust aftertreatment system

PowerPacks for railcars

UNDERFLOOR AND
ROOF INSTALLATION

– Horizontally mounted inline engines

PowerPack model		6H 1800 R81P	6H 1800 R82P
Rated power	kW (bhp)	315 (422)	335 (449)
Speed	rpm	1800	1800
Exhaust emissions		EU Stage IIIA compl./EPA Tier3 compl.	EU Stage IIIA compl./EPA Tier3 compl.
Fuel consumption at rated power	g/kWh	214	212
	l/h (gal/h)	81.2 (21.5)	85.6 (22.6)
at best point	g/kWh	198	198
Drive systems ¹⁾		DM/DE	DM/DE
PowerPack – dimensions & masses			
Length (L) ²⁾	mm	2600 - 4000	2600 - 4000
	(in)	(102.4 - 157.5)	(102.4 - 157.5)
Width (W) ²⁾	mm	2100 - 2800	2100 - 2800
	(in)	(82.7 - 110.2)	(82.7 - 110.2)
Height (H) ²⁾	mm	770 - 850	770 - 850
	(in)	(30.3 - 33.5)	(30.3 - 33.5)
Mass, dry ²⁾	kg	2900 - 4000	2900 - 4000
	(lbs)	(6393 - 8819)	(6393 - 8819)
Mass, wet ²⁾	kg	3050 - 4200	3050 - 4200
	(lbs)	(6724 - 9259)	(6724 - 9259)
Engine main data			
No. of cylinders/arrangement		6/inline	6/inline
Bore/Stroke	mm	128/166	128/166
	(in)	(5.0/6.5)	(5.0/6.5)
Displacement/cyl.	l (cu in)	2.14 (130)	2.14 (130)
Displacement, total	l (cu in)	12.8 (782)	12.8 (782)

1) Drive systems: DM = diesel mechanical; DE = diesel electrical

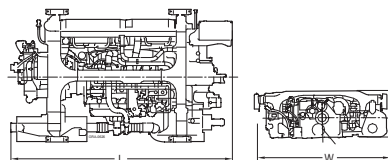
315 KW – 390 KW
(422 BHP – 523 BHP)

Dimensions: PowerPacks with standard equipment

6H 1800 R83P	6H 1800 R84P
360 (483)	390 (523)
1800	1800
EU Stage IIIA compl./EPA Tier3 compl.	EU Stage IIIA compl./EPA Tier3 compl.
212	216
92.0 (24.3)	101.5 (26.8)
198	198
DM/DE	DM/DE
2600 - 4000	2600 - 4000
(102.4 - 157.5)	(102.4 - 157.5)
2100 - 2800	2100 - 2800
(82.7 - 110.2)	(82.7 - 110.2)
770 - 850	770 - 850
(30.3 - 33.5)	(30.3 - 33.5)
2900 - 4000	2900 - 4000
(6393 - 8819)	(6393 - 8819)
3050 - 4200	3050 - 4200
(6724 - 9259)	(6724 - 9259)
6/inline	6/inline
128/166	128/166
(5.0/6.5)	(5.0/6.5)
2.14 (130)	2.14 (130)
12.8 (782)	12.8 (782)

2) Depending on scope of supply
Further variations on demand

PowerPacks for railcars

UNDERFLOOR AND
ROOF INSTALLATION

- Horizontally mounted inline engines

PowerPack model		6H 1800 R76	6H 1800 R86
Rated power	kW (bhp)	315 (422)	375 (503)
Speed	rpm	1800	1800
Exhaust emissions		EU Stage V	EU Stage V
Fuel consumption			
at rated power*	g/kWh	205	205
	l/h (gal/h)	77.8 (20.6)	92.6 (24.5)
at best point	g/kWh	191	190
Drive systems ¹⁾		DM/DE/Hybrid	DM/DE/Hybrid
PowerPack – dimensions & masses			
Length (L) ²⁾	mm	1479	1479
	(in)	(58.23)	(58.23)
Width (W) ²⁾	mm	1470	1470
	(in)	(57.87)	(57.87)
Height (H) ²⁾	mm	2720	2720
	(in)	(28.35)	(28.35)
Mass, dry ²⁾	kg	1070	1070
	(lbs)	(2359)	(2359)
Mass, wet ²⁾	kg	3800 - 5100	3800 - 5100
	(lbs)	(8378 - 11244)	(8378 - 11244)
Engine main data			
No. of cylinders/arrangement		6/inline	6/inline
Bore/Stroke	mm	128/166	128/166
	(in)	(5.0/6.5)	(5.0/6.5)
Displacement/cyl.	l (cu in)	2.14 (130)	2.14 (130)
Displacement, total	l (cu in)	12.8 (782)	12.8 (782)

1) Drive systems: DM = diesel mechanical; DE = diesel electrical

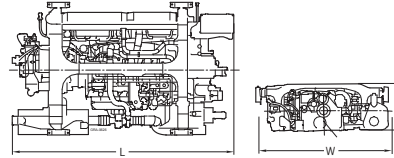
315 KW – 375 KW
(422 BHP – 503 BHP)

Dimensions: PowerPacks with standard equipment

2) Depending on scope of supply
Further variations on demand

* preliminary

PowerPacks for railcars

UNDERFLOOR INSTALLATION



— For underfloor installation

565 KW – 700 KW
(758 BHP – 939 BHP)

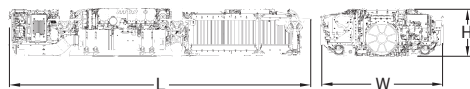

Dimensions: PowerPacks with standard equipment

PowerPack model		12V 1600 R70P	12V 1600 R70LP
Rated power	kW (bhp)	565 (758)	625 (838)
Speed	rpm	2100	2100
Exhaust emissions		EU Stage IIIB compliant	EU Stage IIIB compliant
Fuel consumption			
at rated power	g/kWh	207	207
	l/h (gal/h)	140.9 (37.2)	155.9 (41.2)
at best point	g/kWh	190	190
Drive systems ¹⁾		DE	DE
PowerPack – dimensions & masses			
Length (L) ²⁾	mm	3900 - 5000	3900 - 5000
	(in)	(153.5 - 196.9)	(153.5 - 196.9)
Width (W) ²⁾	mm	2100 - 2800	2100 - 2800
	(in)	(82.7 - 110.2)	(82.7 - 110.2)
Height (H) ²⁾	mm	850 - 950	850 - 950
	(in)	(31.5 - 37.4)	(31.5 - 37.4)
Mass, dry ²⁾	kg	4500 - 6500	4500 - 6500
	(lbs)	(9921 - 14330)	(9921 - 14330)
Mass, wet ²⁾	kg	4700 - 6750	4700 - 6750
	(lbs)	(10362 - 14881)	(10362 - 14881)
Engine main data			
No. of cylinders/arrangement		12	12
Bore/Stroke	mm	122/150	122/150
	(in)	(4.8/5.9)	(4.8/5.9)
Displacement/cyl.	l (cu in)	1.75 (107)	1.75 (107)
Displacement, total	l (cu in)	21.0 (1284)	21.0 (1284)

1) Drive systems: DE = diesel electrical

12V 1600 R80P		12V 1600 R80LP	
Rated power	kW (bhp)	660 (885)	700 (939)
Speed	rpm	1900	1900
Exhaust emissions		EU Stage IIIB compliant	EU Stage IIIB compliant
Fuel consumption			
at rated power	g/kWh	200	200
	l/h (gal/h)	159.0 (42.0)	168.7 (44.6)
at best point	g/kWh	191	191
Drive systems ¹⁾		DE	DE
PowerPack – dimensions & masses			
Length (L) ²⁾	mm	3900 - 5000	3900 - 5000
	(in)	(153.5 - 196.9)	(153.5 - 196.9)
Width (W) ²⁾	mm	2100 - 2800	2100 - 2800
	(in)	(82.7 - 110.2)	(82.7 - 110.2)
Height (H) ²⁾	mm	850 - 950	850 - 950
	(in)	(31.5 - 37.4)	(31.5 - 37.4)
Mass, dry ²⁾	kg	4500 - 6500	4500 - 6500
	(lbs)	(9921 - 14330)	(9921 - 14330)
Mass, wet ²⁾	kg	4700 - 6750	4700 - 6750
	(lbs)	(10362 - 14881)	(10362 - 14881)
Engine main data			
No. of cylinders/arrangement		12	12
Bore/Stroke	mm	122/150	122/150
	(in)	(4.8/5.9)	(4.8/5.9)
Displacement/cyl.	l (cu in)	1.75 (107)	1.75 (107)
Displacement, total	l (cu in)	21.0 (1284)	21.0 (1284)

2) Depending on scope of supply
Further variations on demand

PowerPacks for railcars

UNDERFLOOR INSTALLATION

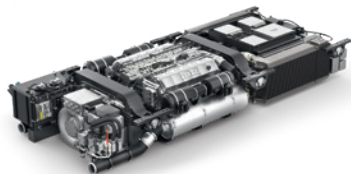

— For underfloor installation

565 KW – 736 KW
(758 BHP – 987 BHP)

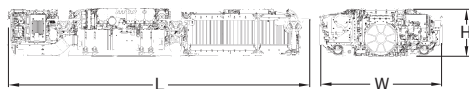

Dimensions: PowerPacks with standard equipment

PowerPack model		12V 1600 R71	12V 1600 R71L
Rated power	kW (bhp)	565 (758)	625 (838)
Speed	rpm	1900	1900
Exhaust emissions		EU Stage V	EU Stage V
Fuel consumption			
at rated power	g/kWh	192	190
	l/h (gal/h)	130.7 (34.5)	143.1 (37.8)
at best point	g/kWh	184	183
Drive systems ¹⁾		DE	DE
PowerPack – dimensions & masses			
Length (L) ²⁾	mm	3900 - 5000	3900 - 5000
	(in)	(153.5 - 196.9)	(153.5 - 196.9)
Width (W) ²⁾	mm	2100 - 2800	2100 - 2800
	(in)	(82.7 - 110.2)	(82.7 - 110.2)
Height (H) ²⁾	mm	850 - 950	850 - 950
	(in)	(31.5 - 37.4)	(31.5 - 37.4)
Mass, dry ²⁾	kg	4500 - 6500	4500 - 6500
	(lbs)	(9921 - 14330)	(9921 - 14330)
Mass, wet ²⁾	kg	4700 - 6750	4700 - 6750
	(lbs)	(10362 - 14881)	(10362 - 14881)
Engine main data			
No. of cylinders/arrangement		12	12
Bore/Stroke	mm	122/150	122/150
	(in)	(4.8/5.9)	(4.8/5.9)
Displacement/cyl.	l (cu in)	1.75 (107)	1.75 (107)
Displacement, total	l (cu in)	21.0 (1284)	21.0 (1284)

1) Drive systems: DE = diesel electrical

	12V 1600 R81L	12V 1600 R91
Rated power	700 (939)	736 (987)
Speed	1900	1900
Exhaust emissions	EU Stage V	EU Stage V
Fuel consumption		
at rated power	191	192
	161.1 (42.6)	170.3 (45.0)
at best point	183	183
Drive systems ¹⁾	DE	DE
PowerPack – dimensions & masses		
Length (L) ²⁾	4100 - 5350	4100 - 5350
	(161.4 - 210.6)	(161.4 - 210.6)
Width (W) ²⁾	2100 - 2800	2100 - 2800
	(82.7 - 110.2)	(82.7 - 110.2)
Height (H) ²⁾	850	850
	(31.5)	(31.5)
Mass, dry ²⁾	4500 - 6500	4500 - 6500
	(9921 - 14330)	(9921 - 14330)
Mass, wet ²⁾	4700 - 6750	4700 - 6750
	(10362 - 14881)	(10362 - 14881)
Engine main data		
No. of cylinders/arrangement	12	12
Bore/Stroke	122/150	122/150
	(4.8/5.9)	(4.8/5.9)
Displacement/cyl.	1.75 (107)	1.75 (107)
Displacement, total	21.0 (1284)	21.0 (1284)

2) Depending on scope of supply
Further variations on demand

Performance overview

ENGINES AND SYSTEM SOLUTIONS

* For rail specific usage please contact your local partner

System solutions and engines for engine room installation

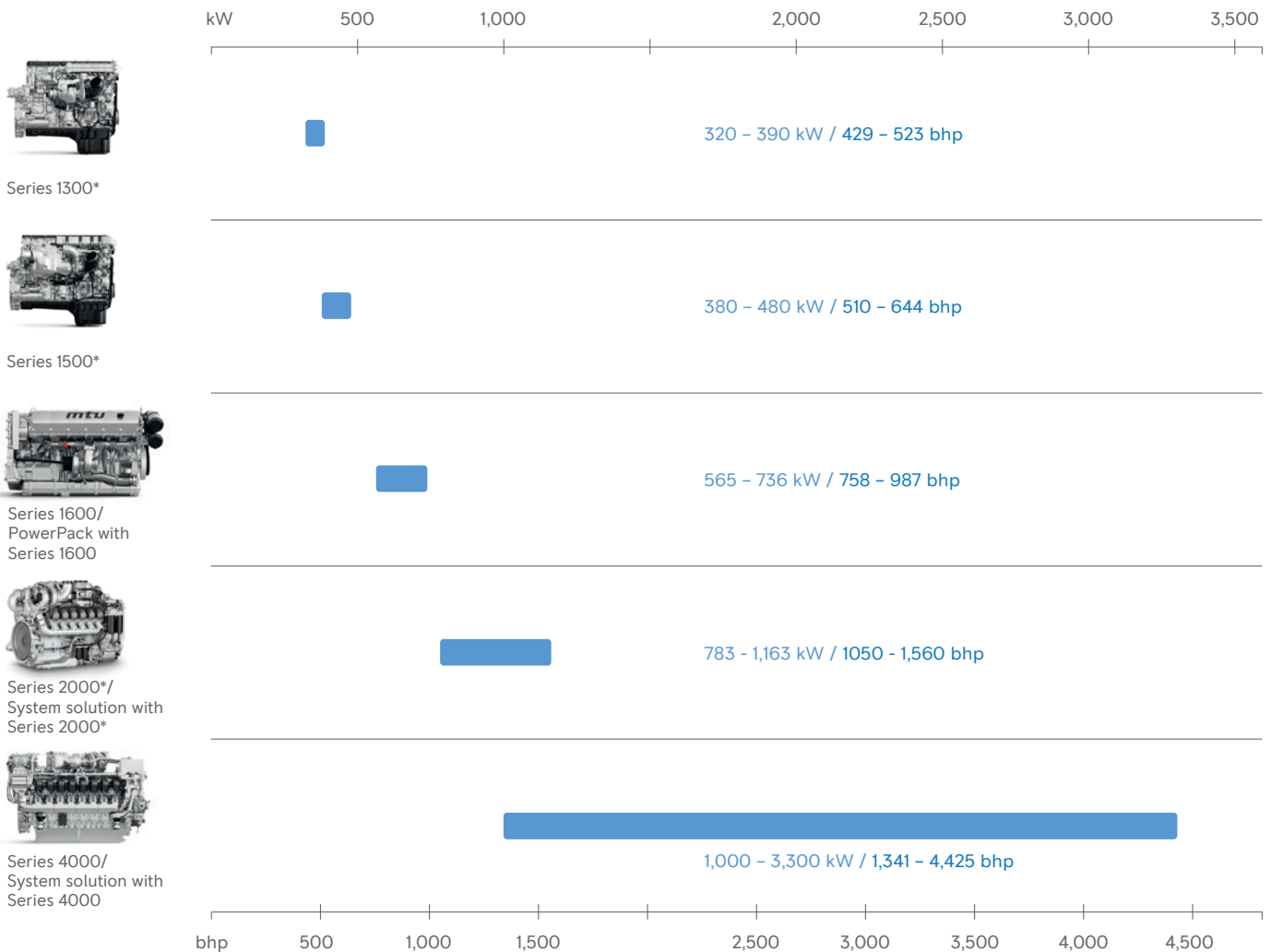

Drive solutions for push-pull trains and locomotives

SYSTEM SOLUTIONS WITH SERIES 4000: ALL-ROUND OVERACHIEVERS

To characterize the **mtu** system solutions with Series 4000 as overachievers is almost an understatement. Talk about durability, dependability and clean operational efficiency. Since 1996, these diesel engines have been installed in well over 3,000 railway applications worldwide.

-
- 1 Generator
 - 2 Exhaust gas aftertreatment solution
 - 3 Engine

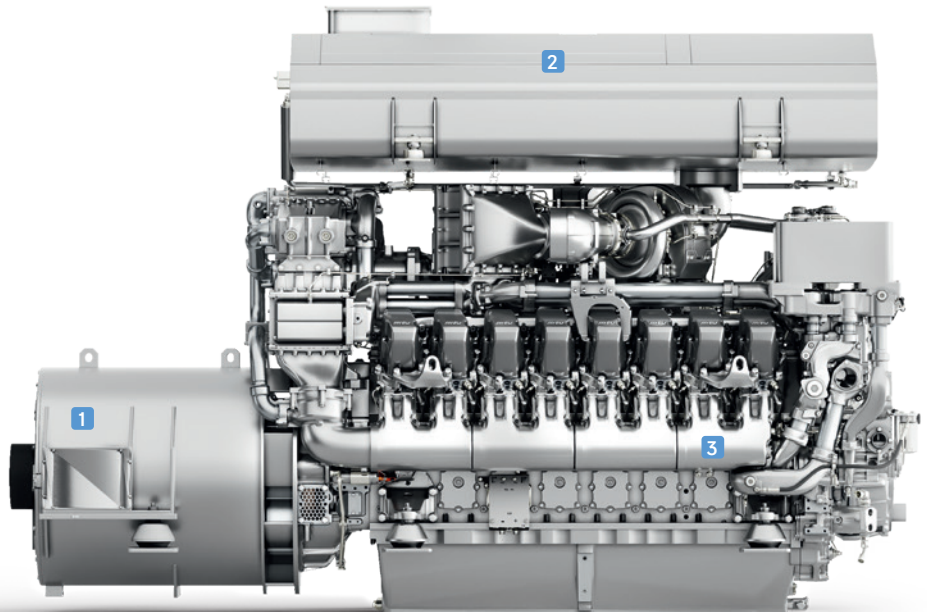

mtu system solutions with Series 4000 benefits

- Simple, single-frame engine and generator installation
- Perfect system component integration based on:
 - Complete torsional vibration analysis for the entire system
 - Calculation of vibration impact on locomotive performance
 - Optimized engine and generator alignment
- Excellent efficiency through common rail fuel injection and advanced engine control
- Superb emissions values: eliminates over 90% of particulates
- Development, commissioning and service warranty all handled by one source

Engines

FOR PUSH-PULL TRAINS
AND LOCOMOTIVES

- For new locomotives or repowering
- Economical space requirements

Engine model		12V 1600 R70	12V 1600 R70L
Rated power	kW (bhp)	565 (757)	625 (838)
Speed	rpm	2100	2100
Exhaust emissions		EU Stage IIIB	EU Stage IIIB
Fuel consumption			
at rated power	g/kWh	207	207
	l/h (gal/h)	-	-
at best point	g/kWh	190	190
Engines - dimensions & masses			
Length (L)	mm (in)	1531 (60.3)	1531 (60.3)
Width (W)	mm (in)	1394 (54.9)	1394 (54.9)
Height (H)	mm (in)	850 (33.5)	850 (33.5)
Mass, dry	kg (lbs)	2280 (5027)	2280 (5027)
Mass, wet	kg (lbs)	2390 (5269)	2390 (5269)
Engine main data			
No. of cylinders		12	12
Bore/Stroke	mm	122/150	122/150
	(in)	(4.8/5.9)	(4.8/5.9)
Displacement/cyl.	l (cu in)	1.75 (107)	1.75 (107)
Displacement, total	l (cu in)	21 (1284)	21 (1284)

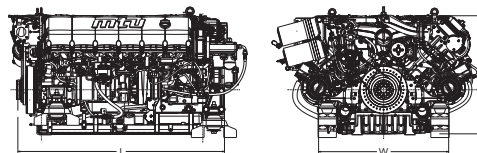
565 KW - 700 KW
(757 BHP - 952 BHP)

Dimensions: Engines with standard equipment

12V 1600 R80	12V 1600 R80L	12V 1600 R71	12V 1600 R71L
660 (885)	700 (952)	565 (757)	625 (838)
1900	1900	1900	1900
EU Stage IIIB	EU Stage IIIB	EU Stage V	EU Stage V
200	200	207	190
-	-	-	-
191	191	190	183
1531 (60.3)	1531 (60.3)	1531 (60.3)	1531 (60.3)
1394 (54.9)	1394 (54.9)	1394 (54.9)	1394 (54.9)
850 (33.5)	850 (33.5)	850 (33.5)	850 (33.5)
2280 (5027)	2280 (5027)	2336 (5150)	2336 (5150)
2390 (5269)	2390 (5269)	2447 (5395)	2447 (5395)
12	12	12	12
122/150	122/150	122/150	122/150
(4.8/5.9)	(4.8/5.9)	(4.8/5.9)	(4.8/5.9)
1.75 (107)	1.75 (107)	1.75 (107)	1.75 (107)
21 (1284)	21 (1284)	21 (1284)	21 (1284)

Engines

FOR PUSH-PULL TRAINS
AND LOCOMOTIVES

- For new locomotives or repowering
- Economical space requirements

Engine model		12V 1600 R81L	12V 1600 R91
Rated power	kW (bhp)	700 (952)	736 (987)
Speed	rpm	1900	1900
Exhaust emissions		EU Stage V	EU Stage V
Fuel consumption at rated power	g/kWh	191	192
	l/h (gal/h)	–	–
at best point	g/kWh	183	183
Engines – dimensions & masses			
Length (L)	mm (in)	1531 (60.3)	1531 (60.3)
Width (W)	mm (in)	1394 (54.9)	1394 (54.9)
Height (H)	mm (in)	850 (33.5)	850 (33.5)
Mass, dry	kg (lbs)	2336 (5150)	2336 (5150)
Mass, wet	kg (lbs)	2447 (5395)	2447 (5395)
Engine main data			
No. of cylinders		12	12
Bore/Stroke	mm (in)	122/150 (4.8/5.9)	122/150 (4.8/5.9)
Displacement/cyl.	l (cu in)	1.75 (107)	1.75 (107)
Displacement, total	l (cu in)	21 (1284)	21 (1284)

1) EU IIIA type approved, UIC IIIA certificate available

2) For rail specific usage please contact your local partner.

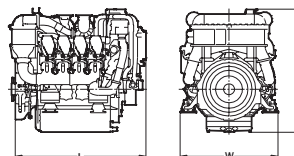
700 KW – 1200 KW
(952 BHP – 1609 BHP)

Dimensions: Engines with standard equipment

12V 2000 C66R ²⁾	8V 4000 R43	16V 2000 S96 ²⁾	8V 4000 R43L
783 (1050)	1000 (1341)	1163 (1560)	1200 (1609)
1800	1800	2100	1800
Emission optimized w/o certificate	EU Stage IIIA compliant ¹⁾ / UIC IIIA	Emission optimized w/o certificate	EU Stage IIIA compliant ¹⁾ / UIC IIIA
200	206	209	206
–	248.2 (65.6)	–	297.8 (78.7)
198	194	195	194
2030 (80)	2000 (78.7)	2370 (94)	2000 (78.7)
1280 (50)	1565 (61.6)	1280 (50)	1565 (61.6)
1460 (57)	1860 (73.2)	1480 (58)	1860 (73.2)
2950 (6500)	5270 (11618)	3350 (7385)	5270 (11618)
3135 (6910)	5610 (12368)	3600 (3935)	5610 (12368)
12	8	16	8
135/165 (5.3/6.2)	170/210 (6.7/8.3)	135/165 (5.3/6.2)	170/210 (6.7/8.3)
2.23 (136)	4.77 (291)	2.23 (136)	4.77 (291)
26.8 (1633)	38.1 (2327)	35.7 (2177)	38.1 (2327)

Engines

FOR PUSH-PULL TRAINS
AND LOCOMOTIVES

- Well differentiated choice of engines spanning wide range of power outputs
- High power-to-weight ratios for lightweight trains

Engine model		12V 4000 R43	12V 4000 R43L
Rated power	kW (bhp)	1500 (2012)	1800 (2414)
Speed	rpm	1800	1800
Exhaust emissions		EU Stage IIIA compliant ¹⁾ / UIC IIIA	EU Stage IIIA compliant ¹⁾ / UIC IIIA
Fuel consumption at rated power	g/kWh	205	210
	l/h (gal/h)	370.5 (97.9)	455.4 (120.3)
at best point	g/kWh	192	190
Engines – dimensions & masses			
Length (L)	mm (in)	2386 (93.9)	2386 (93.9)
Width (W)	mm (in)	1562 (61.5)	1562 (61.5)
Height (H)	mm (in)	2015 (79.3)	2015 (79.3)
Mass, dry	kg (lbs)	6613 (14579)	6613 (14579)
Mass, wet	kg (lbs)	7080 (15609)	7080 (15609)
Engine main data			
No. of cylinders		12	12
Bore/Stroke	mm (in)	170/210 (6.7/8.3)	170/210 (6.7/8.3)
Displacement/cyl.	l (cu in)	4.77 (291)	4.77 (291)
Displacement, total	l (cu in)	57.2 (3491)	57.2 (3491)

1) EU IIIA type approved, UIC IIIA certificate available

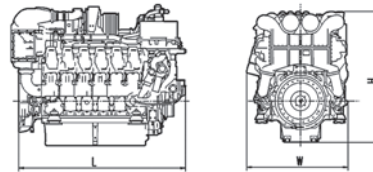
1500 KW – 1800 KW
(2012 BHP – 2414 BHP)

Dimensions: Engines with standard equipment

Engines

FOR PUSH-PULL TRAINS
AND LOCOMOTIVES

- Well differentiated choice of engines spanning wide range of power outputs
- High power-to-weight ratios for lightweight trains
- Meeting emissions regulations EU Stage V

Engine model		12V 4000 R64	12V 4000 R84
Rated power	kW (bhp)	1500 (2012)	1800 (2414)
Speed	rpm	1800	1800
Exhaust emissions		EU Stage IIIB compliant, EU Stage V	EU Stage IIIB compliant, EU Stage V
Fuel consumption at rated power	g/kWh	203	202
	l/h (gal/h)	366.9 (96.9)	438.1 (115.7)
at best point	g/kWh	193	193
Engines – dimensions & masses			
Length (L)	mm (in)	2670 (105.1)	2670 (105.1)
Width (W)	mm (in)	1696 (66.8)	1696 (66.8)
Height (H)	mm (in)	2001 (78.8)	2001 (78.8)
Mass, dry	kg (lbs)	7700 (16976)	7700 (16976)
Mass, wet	kg (lbs)	8200 (18078)	8200 (18078)
Engine main data			
No. of cylinders		12	12
Bore/Stroke	mm (in)	170/210 (6.7/8.3)	170/210 (6.7/8.3)
Displacement/cyl.	l (cu in)	4.77 (291)	4.77 (291)
Displacement, total	l (cu in)	57.2 (3491)	57.2 (3491)

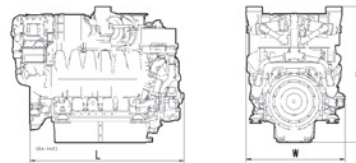
1500 KW – 1800 KW
(2012 BHP – 2414 BHP)

Dimensions: Engines with standard equipment

12V 4000 R54	
Rated power	1800 (2414)
Speed	1800
Exhaust emissions	EPA Tier 3 compliant
Fuel consumption at rated power	199
	431.6 (114.0)
at best point	195
Engines – dimensions & masses	
Length (L)	2670 (105.1)
Width (W)	1696 (66.8)
Height (H)	2001 (78.8)
Mass, dry	7700 (16976)
Mass, wet	8200 (18078)
Engine main data	
No. of cylinders	12
Bore/Stroke	170/210 (6.7/8.3)
Displacement/cyl.	4.77 (291)
Displacement, total	57.2 (3491)

Engines

FOR PUSH-PULL TRAINS
AND LOCOMOTIVES

- Cutting-edge technology with built-in potential
- Uniquely low emissions and consumption
- Market leader in its class for European diesel locomotives

Engine model		16V 4000 R43R	16V 4000 R43
Rated power	kW (bhp)	2000 (2682)	2200 (2950)
Speed	rpm	1800	1800
Exhaust emissions		EU Stage IIIA compliant ¹⁾ / UIC IIIA	EU Stage IIIA compliant ¹⁾ / UIC IIIA
Fuel consumption			
at rated power	g/kWh	207	206
	l/h (gal/h)	498.8 (131.8)	546.0 (144.3)
at best point	g/kWh	196	196
Engines – dimensions & masses			
Length (L)	mm (in)	2865 (112.8)	2865 (112.8)
Width (W)	mm (in)	1562 (61.5)	1562 (61.5)
Height (H)	mm (in)	2015 (79.3)	2015 (79.3)
Mass, dry	kg (lbs)	7930 (17483)	7930 (17483)
Mass, wet	kg (lbs)	8510 (18761)	8510 (18761)
Engine main data			
No. of cylinders		16	16
Bore/Stroke	mm (in)	170/210 (6.7/8.3)	170/210 (6.7/8.3)
Displacement/cyl.	l (cu in)	4.77 (291)	4.77 (291)
Displacement, total	l (cu in)	76.3 (4654)	76.3 (4654)

1) EU IIIA type approved, EU Stage IIIA certificate available

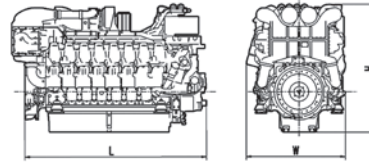
2000 KW – 2400 KW
(2682 BHP – 3218 BHP)

Dimensions: Engines with standard equipment

16V 4000 R43L	
Rated power	2400 (3218)
Speed	1800
Exhaust emissions	EU Stage IIIA compliant ¹⁾ / UIC IIIA
Fuel consumption	
at rated power	205
	592.8 (156.6)
at best point	196
Engines – dimensions & masses	
Length (L)	2865 (112.8)
Width (W)	1562 (61.5)
Height (H)	2015 (79.3)
Mass, dry	7930 (17483)
Mass, wet	8510 (18761)
Engine main data	
No. of cylinders	16
Bore/Stroke	170/210 (6.7/8.3)
Displacement/cyl.	4.77 (291)
Displacement, total	76.3 (4654)

Engines

FOR PUSH-PULL TRAINS
AND LOCOMOTIVES

- Cutting-edge technology with built-in potential
- Uniquely low emissions and low consumption
- Meeting emissions regulations EU Stage V

Engine model		16V 4000 R64	16V 4000 R74
Rated power	kW (bhp)	2000 (2682)	2200 (2950)
Speed	rpm	1800	1800
Exhaust emissions		EU Stage IIIB compliant, EU Stage V	EU Stage IIIB compliant, EU Stage V
Fuel consumption at rated power	g/kWh	201	202
	l/h (gal/h)	484.3 (128.0)	535.4 (141.5)
at best point	g/kWh	190	190
Engines – dimensions & masses			
Length (L)	mm (in)	3140 (123.6)	3140 (123.6)
Width (W)	mm (in)	1696 (66.8)	1696 (66.8)
Height (H)	mm (in)	2001 (78.8)	2001 (78.8)
Mass, dry	kg (lbs)	9050 (19952)	9050 (19952)
Mass, wet	kg (lbs)	9670 (21319)	9670 (21319)
Engine main data			
No. of cylinders		16	16
Bore/Stroke	mm (in)	170/210 (6.7/8.3)	170/210 (6.7/8.3)
Displacement/cyl.	l (cu in)	4.77 (291)	4.77 (291)
Displacement, total	l (cu in)	76.3 (4654)	76.3 (4654)

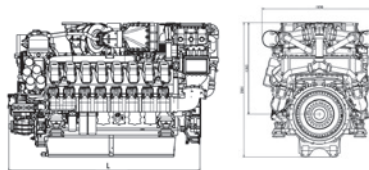
2000 KW – 2400 KW
(2682 BHP – 3218 BHP)

Dimensions: Engines with standard equipment

16V 4000 R84	16V 4000 R54
2400 (3218)	2400 (3218)
1800	1800
EU Stage IIIB compliant, EU Stage V	EPA Tier 3 compliant
199	199
575.4 (152.0)	575.4 (152.0)
190	195
3140 (123.6)	3140 (123.6)
1696 (66.8)	1696 (66.8)
2001 (78.8)	2001 (78.8)
9050 (19952)	9050 (19952)
9670 (21319)	9670 (21319)
16	16
170/210 (6.7/8.3)	170/210 (6.7/8.3)
4.77 (291)	4.77 (291)
76.3 (4654)	76.3 (4654)

Engines

FOR PUSH-PULL TRAINS
AND LOCOMOTIVES

- Outstanding power density. Unbeaten power-to-weight ratio
- Up to 3,300 kW for 4-axle locomotives and 6-axle locomotives

Engine model		20V 4000 R43	20V 4000 R63R
Rated power	kW (bhp)	2700 (3621)	2700 (3621)
Speed	rpm	1800	1800
Exhaust emissions		EU Stage IIIA compliant ¹⁾ / UIC IIIA	EU Stage IIIA compliant/ UIC IIIA
Fuel consumption at rated power	g/kWh	208	204
	l/h (gal/h)	676.6 (178.8)	663.6 (175.3)
at best point	g/kWh	194	194
Engines – dimensions & masses			
Length (L)	mm (in)	3335 (131.3)	3592 (141.4)
Width (W)	mm (in)	1562 (61.5)	1570 (61.8)
Height (H)	mm (in)	2015 (79.3)	2015 (79.3)
Mass, dry	kg (lbs)	9860 (21738)	10400 (22928)
Mass, wet	kg (lbs)	10520 (23193)	11070 (24405)
Engine main data			
No. of cylinders		20	20
Bore/Stroke	mm (in)	170/210 (6.7/8.3)	170/210 (6.7/8.3)
Displacement/cyl.	l (cu in)	4.77 (291)	4.77 (291)
Displacement, total	l (cu in)	95.3 (5818)	95.3 (5818)

1) EU IIIA type approved, EU Stage IIIA certificate available

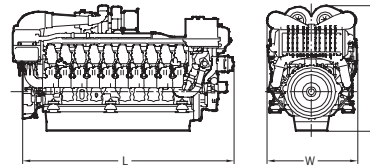
2700 KW – 3300 KW
(3621 BHP – 4425 BHP)

Dimensions: Engines with standard equipment

20V 4000 R43L	20V 4000 R63	20V 4000 R63L
3000 (4023)	3000 (4023)	3300 (4425)
1800	1800	1800
EU Stage IIIA compliant ¹⁾ / UIC IIIA	EU Stage IIIA compliant/ UIC IIIA	EU Stage IIIA compliant/ UIC IIIA
210	206	206
759.0 (200.5)	744.6 (196.7)	819.0 (216.4)
194	197	195
3335 (131.3)	3592 (141.4)	3592 (141.4)
1562 (61.5)	1570 (61.8)	1570 (61.8)
2015 (79.3)	2015 (79.3)	2015 (79.3)
9860 (21738)	10400 (22928)	10400 (22928)
10520 (23193)	11070 (24405)	11070 (24405)
20	20	20
170/210 (6.7/8.3)	170/210 (6.7/8.3)	170/210 (6.7/8.3)
4.77 (291)	4.77 (291)	4.77 (291)
95.3 (5818)	95.3 (5818)	95.3 (5818)

References

DIESEL ENGINES AND POWERPACKS
IN RAILCARS/PUSH-PULL
TRAINS AND LOCOMOTIVES

Locomotives

Siemens Mobility
EuroRunner, Vectron DE and
Dual Mode
1500 - 2400 kW /
2012 - 3218 bhp



CNR
Dalian DL class
1 x 2700 kW



Vossloh DE12 and DE18
mtu Series 4000 diesel engine
1200 - 1800 kW /
1609 - 2413 bhp



CZ LOKO
2200 kW / 2950 bhp



CRRC
mtu 16V 4000 R43 diesel
engines
2200 kW / 2950 bhp



Railcars

© Federico Santiaggi



Alstom Link
2x *mtu* PowerPack Series 1800
390 kW / 523 bhp



PESA Link
mtu PowerPack
565 - 736 kW / 758 - 987 bhp



CAF
mtu PowerPack Series 1800
375-390 kW / 503-523 bhp



Porterbrook
mtu Hybrid PowerPack Series
1800
315 kW / 422 bhp (mechanical)
150 kW / 201 bhp (electrical)



RZD and Serbian Railway
mtu PowerPack Series 1800
360 kW / 483 bhp

References

DIESEL ENGINES AND
POWERPACKS FOR
SPECIAL-PURPOSE RAIL VEHICLES

- Individual traction system solutions
- Flexibility in design and installation

Remote-controlled shunter



Fire fighting and rescue train

Auxiliary locomotive for
tunnel operations

Railroad inspection vehicle



Further applications with **mtu** system solutions are e.g.:

- Locomotives for underground railways
- Mountain railways

- Emissions optimized engines for tunnel operations with particle filter/exhaust catalyst



Rotary Snow-Plow

Grinding train



Track layer



Rail crane



Overhead line inspection railcar



Repowering solutions

ECONOMIC ALTERNATIVES.

Repowering existing railcars and locomotives with **mtu** engines is an economically sound alternative to new purchases. Installing a modern mtu diesel engine and systems offers many benefits, including low fuel consumption, reduced downtime, long service intervals and low maintenance. They can significantly reduce operating costs and optimize economic value.

Repowering solutions for locomotives and railcars offer a tried and tested economic alternative to placing a new order with four positive effects:

- Using a modern diesel engine reduces operating and maintenance costs while maximizing the economic benefits.
- Legally stipulated exhaust gas emission standards are met and noise levels significantly reduced.
- Vehicle availability and reliability are brought up to the level of a new vehicle.
- The cost of investment is considerably lower than a new vehicle.

Following conversion, the reduced operating costs enable many potential savings:

- Reduction in fuel costs.
- Extended maintenance intervals and minimized costs thanks to new maintenance concept.
- Legal requirements are met by proven combustion technology; lower fuel and oil consumption lead to reduced pollutant emissions, thus benefitting the environment.
- Lower investment costs through reduced reserve locomotive stock.
- Limited downtime thanks to high availability and reliability.

As a rail industry partner with extensive experience, we not only repower engines, but also provide a comprehensive package of other support services:

- From the design phase to drive system implementation – active support and professional engineering at all stages of the repowering project.
- Supply of the latest, extensively tested engines and PowerPacks featuring compact designs and excellent power-to-weight ratios enabling easy installation, even of higher outputs without permissible axle loads being exceeded.



Automation solutions

DRIVE SYSTEM CONTROL.

Serving as the operational brain, the PowerControl Automation system monitors and controls the drive system, its components.

PowerControl Automation continually monitors the entire drive system, ensuring maximum drive power availability while optimizing performance efficiency, fuel consumption and emissions reduction – for all types of railcars and in all types of climatic environments.

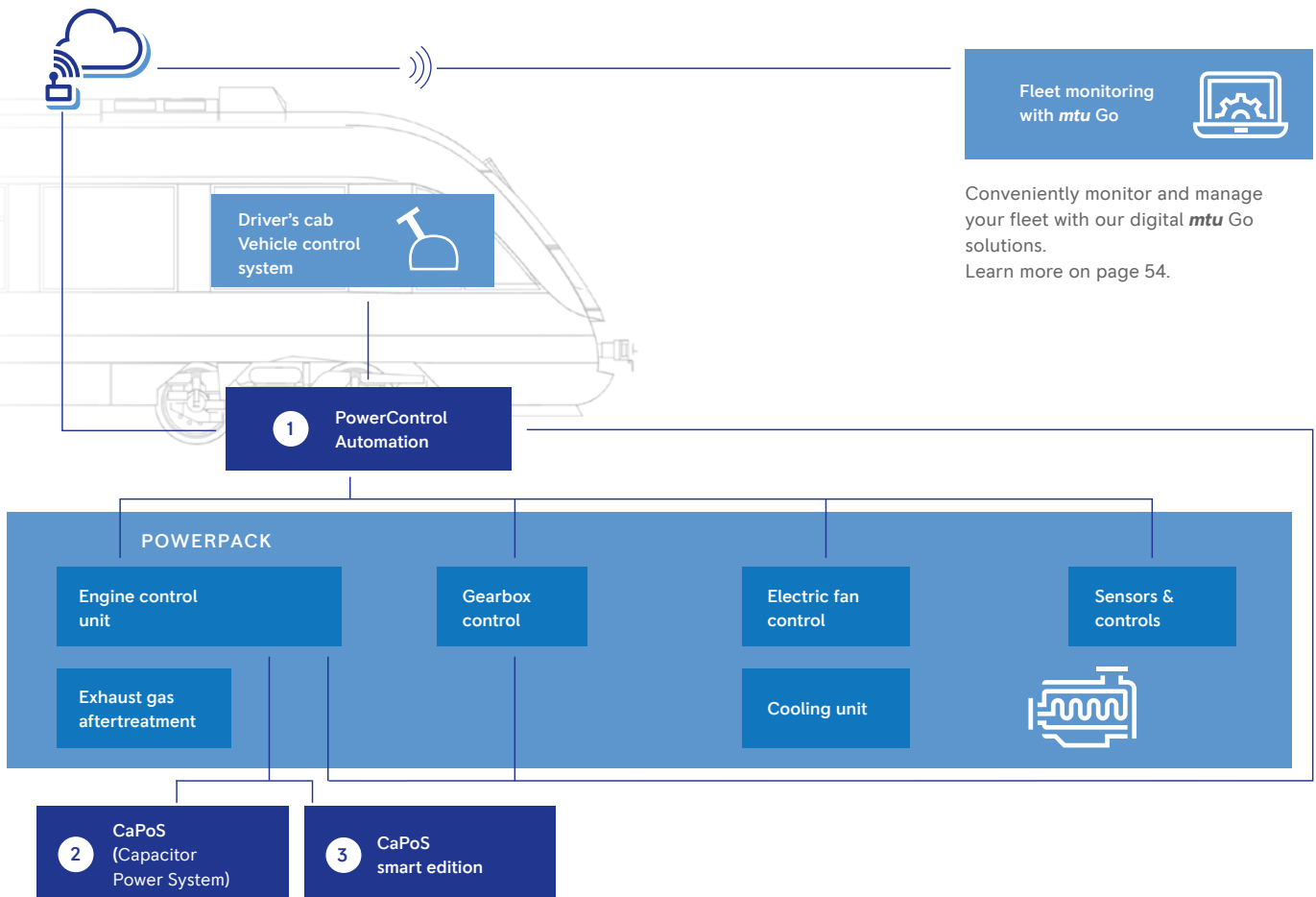

You will find more details on the next page.

Automation solutions

ENHANCED AUTOMATION
FUNCTIONS.

Designed as a modular platform that easily integrates with wide-ranging rail drive control systems, PowerControl Automation functions can be further enhanced with the optional systems CaPoS and CaPoS smart edition.

CaPoS

Innovatively optimizing cold start-up behaviour, the capacitor power system CaPoS marks a great improvement over conventional starter batteries.

Automation system	1 PowerControl Automation
	
Descriptions	Lets you digitally monitor and maximize the performance and safety of your entire fleet.
Advantages at a glance	<ul style="list-style-type: none"> – Complete, high-connectivity automation control solution – Easy to integrate and scalable for wide-ranging applications – For new rolling stock and repowering – Monitors all critical operational functions of the entire PowerPack
Available for rail engines and PowerPacks: Series 1600, 1800 & 4000	

Implemented safety functions

SIL 1





SIL 2

- Avoidance of unwanted traction
- Protection against overspeeds
- Safe shutdown of the PowerPack, if required (Emergency stop)
- Safe uncoupling

CaPoS smart edition

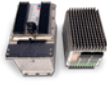
Featuring an integrated starter with 24V onboard, the CaPoS smart edition is ideal for the heavy duty start-up tasks of Series 1600, 1800 and 4000 engines.

2 CaPoS (Capacitor Power System)	3 CaPoS smart edition
	
Innovatively optimizes cold start-up behaviour, replacing conventional starter batteries.	Capacitor power system designed specifically for heavy duty tasks such as 24V DC starting sequences.
<ul style="list-style-type: none"> – Optimized cold-starting properties – Autonomous, modular and maintenance-free design – Low lifecycle costs – Electrical system voltage: 16V DC – 154V DC – CAN interface 	<ul style="list-style-type: none"> – Stand-alone component with integral charger – Optimized cold-starting capabilities – Autonomous, modular and maintenance-free design – Low lifecycle costs – 24V DC onboard voltage – Integrated DC-/DC converter for automatic recharging – IP66 protection
For Locomotives	For PowerPacks

mtu Service solutions

mtu SERVICE SOLUTIONS - A LIFETIME OF VALUE

Our service solutions for engines and drive systems are designed to maximize performance, extend life, and provide expert support. These solutions are categorized into three main value propositions: Secure, Sustain, and Support.

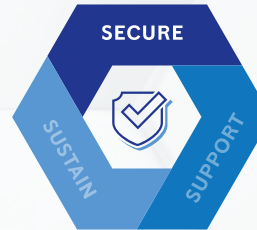

Enjoy peace of mind with maximizing asset performance and reducing operational risks

- Extended coverage
- **mtu** ValueCare Agreements
- Digital solutions

Extending equipment life and reducing costs while protecting the environment

- Reman/overhaul solutions
- New exchange engine
- Upgrades and refits

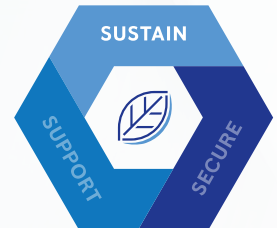

Expert service from a reliable partner to keep operations running smoothly

- Support services
- Genuine spare parts & consumables
- Training
- Maintenance & repair



Extended coverage

PROTECT YOUR
INVESTMENT

mtu engines and systems —backed by extended coverage — provide invaluable peace of mind beyond the standard warranty.

With extended coverage, you can be assured that the costs of unplanned repairs are covered, with service performed by **mtu**-certified technicians — upholding resale value and ensuring long-term confidence in your **mtu** investment.

Avoid the unexpected

Extended coverage protects you from the cost of unexpected repairs beyond your standard warranty, with professional service from **mtu**-certified technicians and coverage tailored to your needs. Packages can also be extended up to five years and are fully transferable, enhancing resale value. Coverage includes all materials and labor for troubleshooting, fault clearance, and corrective services to engines and on-engine electronics (excluding gearbox, alternators or similar components). To ensure maximum quality, all repairs are conducted using only genuine **mtu** parts.

Your benefits:



Flexible options and local support to suit your needs (e.g. operating hours)



100 % genuine parts and components



Protection against unexpected repair costs

mtu ValueCare AgreementsPROTECT YOUR
INVESTMENT

You've got a tough job. Get the power, performance and peace of mind to get it done right with **mtu** ValueCare Agreements — tailored support throughout the life of your equipment.

In your world, every second counts. Our digitally connected propulsion systems, wrapped in ValueCare Agreements, make it easy to keep your business running smoothly and reduce total cost of ownership by maximizing uptime, optimizing lifecycle costs and helping you avoid equipment-related business disruptions through preventive maintenance. That's why it pays to plan ahead by investing in a superior **mtu** system and protecting it with our ValueCare Agreement.

Tailored solutions to move your business forward:

**mtu** ValueCare Agreements helps you

- Increase operational uptime
- Guarantee parts availability and service quality
- Predict equipment-related costs
- Optimize maintenance planning
- Connect to us, 24/7
- Attain peace of mind

Digital solutions

YOUR POWER.
YOUR SERVICE.
CONNECTED.



Rail applications have great demands on engines and drive systems. Ensuring that propulsions are constantly available for optimum use, means making the right maintenance decisions. Our digital solutions enable you to keep track of operating hours, system alarms and maintenance schedules so you can plan service intervals more effectively.

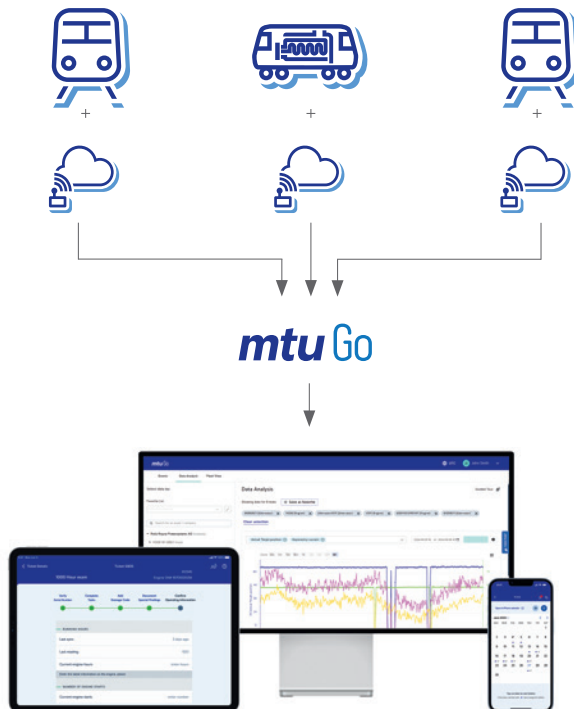

mtu Go



Delivering actionable insights through digital solutions



Connect all your equipment

Data collection from your fleet, asset, system and engine



Asset Management

Access comprehensive real-time and recent performance data for all assets worldwide, conveniently from one centralized platform



Equipment Health Management

Digital solutions for your detailed data analysis on necessary actions

mtu Go links your data with our engineering knowledge and experience from thousands of other assets in one global view to provide insights that enrich your business. For details, please scan the QR Code or visit www.mtu-go.com

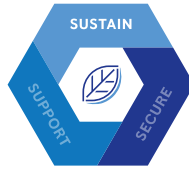

Reman/overhaul solutions

EXCHANGE
AND SAVE.

Factory remanufactured products deliver the same high standards of performance, service life and quality as new products, along with identical warranty coverage – at a fraction of the cost. And with design and model-related updates, they also feature similar technological advancements. Developed by R&D engineers, the remanufacturing process saves you time and money, while benefiting the environment through the reuse of materials. To help you work efficiently, a wide range of remanufactured parts, engines and systems are available worldwide.

Reduce lifecycle costs

As you evaluate your long-term power needs, you must consider a variety of factors. Factory remanufactured products are a smart solution, helping you to reduce the total lifecycle cost of your equipment.

Save time

Factory remanufactured products put your equipment back to work faster than an overhaul, which reduces downtime, service time and indirect costs such as storage.

Our maintain standards

All products are remanufactured/overhauled to our strict standards by certified technicians at our regional centres. We remanufacture/overhaul parts, engines and/or systems to both original and upgraded factory specifications.

Protect the environment

Since remanufacturing is an efficient use of resources and energy, factory remanufactured products benefit the environment as well.

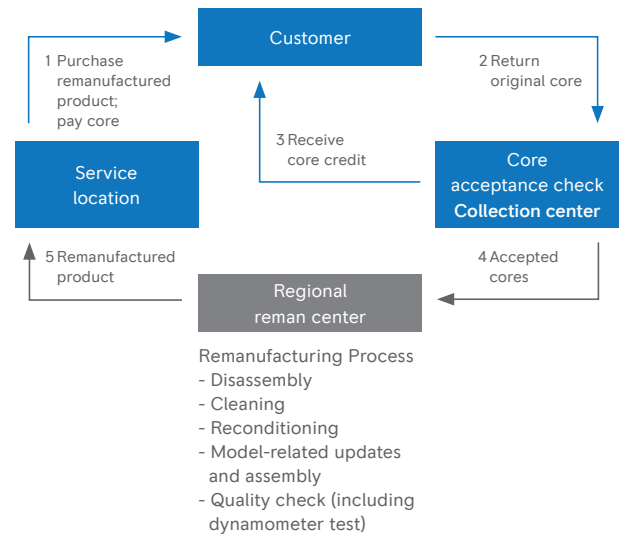
Exchange Process

- 1 Customer purchases remanufactured product from local service partner and pays the core deposit.
- 2 Customer's original core is returned to collection center by local service partner for core acceptance check.
- 3 Customer receives core credit based on the core's technical condition.
- 4 Accepted cores are sent to regional reman centers, where the remanufacturing process takes place.
- 5 Remanufactured products are delivered to our service partners and made available for purchase.



Support services

YOUR LOCAL SUPPORT — WORLDWIDE



The most important part of your propulsion system isn't a part at all — it's your local service team. With more than 1,200 service locations worldwide — backed by regional Parts Logistics Centers in Europe, Asia and America — you can count on responsive support by expert technicians, wherever work takes you. To find your local service partner, visit www.mtu-solutions.com.



Expert service from a reliable partner

On-Demand Support—including professional inspections and preventive maintenance recommendations from us—helps you identify and address problems early, save on repairs or unexpected downtime, and optimize your equipment's performance and longevity. Inspections include visual assessment, test run and leak check, on-site oil and coolant analysis, diagnostic evaluation and reporting.

Always on call, 24/7

Whether it's connecting you with a local service partner or assigning an urgent problem to a dedicated team of our experts, we're ready to assist you — wherever you are, whatever you need.

Europe, Middle East, Africa +49 7541 90-77777

Asia/Pacific +65 6860 9669

North and Latin America +1 248 560 8888

info@ps.rolls-royce.com



Emission reduction solutions

SERIES EMISSIONS
CERTIFICATIONS.

* EU IIIA type approved. Under special preconditions certification available on request.

** For rail specific usage please contact your local partner.

Engine model	Emissions standards							
	Emission optimized w/o certificate	UIC IIIA	EU Stage IIIA compliant		EU Stage IIIB compliant	EU Stage V	EPA Tier 3 compliant	EU Nonroad St V (2016/1628) + EPA Nonroad T4
PowerPacks for roof & underfloor installations								
PowerPack Series 1800			■		■	■	■	
PowerPack Series 1600					■	■		
System solutions & engines for engine room installation								
Series 1300**								■
Series 1500**								■
Series 1600					■	■		
12V/16V 2000**	■							
8V/12V/16V/20V 4000 R43*		■	■					
20V 4000 R63		■	■					
12V/16V 4000 R54							■	
12V/16V 4000 R64/74/84					■	■		

Emission reduction solutions

CLEAN EFFICIENCY.
KEY GREEN TECHNOLOGIES.

Our advanced emission reduction solutions combine key technologies to meet current and future emissions standards as well as reduce fuel consumption. They are designed to ensure smooth system component interaction and clean operational efficiency.

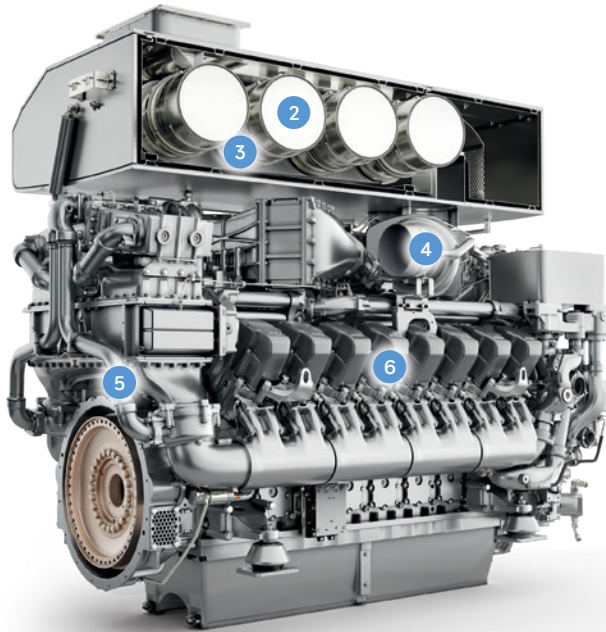

Example based on the Series 4000:
EU Stage IIIB and V with DPF and DOC.
IIIA w/o aftertreatment.

1 Selective catalytic reduction (SCR)

Our SCR solution removes up to 90 percent of nitrogen oxide from exhaust gas. A closed-loop control system prevents ammonia slip during operation. Its fuel and space-efficient design is also very maintenance friendly.

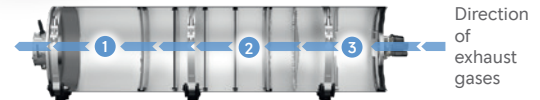
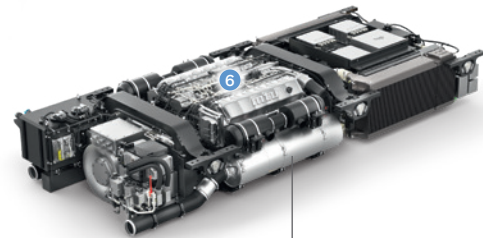

Example based on the PowerPack Series 1600:
EU Stage IIIB with SCR,
EU Stage V with SCR plus DPF and DOC

2 Diesel particulate filter (DPF)

Our diesel particulate filters reduce soot emissions to levels that, in some cases, are well below statutory limits.

3 Diesel oxidation catalyst (DOC)

Easy to install and highly effective in the breakdown of exhaust pollutants – our diesel oxidation catalysts exceed regulatory standards.

4 Two-stage turbocharging

With our two-stage turbocharging, engines achieve high output across a wide speed range and superb fuel efficiency. Their space-saving engine integration offers additional benefits.

5 Exhaust gas recirculation (EGR)

Modern EGR solutions can reduce nitrogen oxide generation within the cylinder by more than 40%. We have designed a highly compact one that integrates all EGR components. It enables the cost-effective upgrade of rail vehicles for compliance with new emissions standards.

6 Common rail injection

Our common rail injection solutions have been enhancing rail engine combustion processes for over 20 years already, making them especially clean and economical.



Emission reduction solutions

HVO - YOUR FAST TRACK TICKET TO LOWER EMISSIONS



Lower emissions

With HVO, you can significantly reduce your emissions already today using your existing **mtu** diesel engines. Take a look at our numbers: Up to 90% reduction for CO₂, ~40% reduction for particle matter (~50-80% PM reduction in power generation applications) and ~8% reduction for NO_x.



No power loss

Our tests with HVO confirm that **mtu** engines perform equally as well when using HVO (as compared to fossil diesel) in terms of maximum power, load acceptance and fuel consumption.



Shelf life

The storage stability of pure HVO (without 1st gen. biodiesel = FAME) is significantly better than that of pure FAME, HVO/FAME mixtures or even fossil diesel, making it even more attractive to emergency power system operators.



Drop-in Fuel

HVO is a drop-in fuel, which means that there are generally no adaptations needed to the diesel genset hardware and software (fuel can be blended with fossil diesel in all proportions or pure – 100% concentration).

HVO belongs to the group of paraffinic diesel fuels (EN15940 & ASTM D975). This renewable fuel is produced by hydro-treatment process and is already tested and approved for many **mtu** engines and systems. With HVO you can save significantly on emissions already today using your existing diesel systems.



Properties

HVO is a clear and colourless liquid with a density slightly below that of diesel. Therefore, HVO exhibits a higher cetane number, when compared to the fossil counterpart and thus burns more efficiently, cleanly and with significantly reduced soot production.

Availability

The excellent ISCC-certified HVO product of our fuel supply partner Neste called “Neste MY Renewable Diesel” is available in Germany, Finland, the Baltic countries, Sweden, Denmark, Belgium, the Netherlands and the US.

Production

HVO as a fuel is obtained by processing organic materials such as vegetable oils, animal fats or cultivated food crops. In the production from plant materials, an almost closed carbon cycle is created. As a plant, the raw material absorbs CO₂ from the atmosphere and thus reduces the effect on the CO₂ balance through subsequent use in the combustion engine.

EXHAUST EMISSIONS

Many countries have implemented environmental legislation to protect people from consequences of polluted air. For this reason an increasing number of countries regulate emissions from specific mobile and stationary sources.

Emission standards may apply internationally, nationally and/or for specific areas. The enforcement of an emission legislation may depend for example on the area where the equipment is used and the way it is operated. The emission legislations may be categorized by power range and/or cylinder capacity.

Emission legislations generally require a type approval which states compliance. Stationary applications may require on-site approvals (on-site emission test) depending on the particular emission legislation.

Please find as follows examples of emission standards which apply to the rail industry. For details please consult the applicable legislation and/or permitting authority.

- European emission legislation differentiates between locomotive and railcar applications.
- US emission legislation differentiates between line-haul and switch-haul locomotive applications.
- US rail emission legislation is specific for ratings 750 kW and above. For ratings below 750 kW nonroad mobile machinery legislation applies.
- UIC (International railway association) emission standards may be applied when national legislations is not available

Examples for emission level description:

- type approval - e.g. EU Nonroad St V (2016/1628)
- compliant with CoC -
e.g. EU Nonroad St IIIA Comp (97/68/EC)
- compliant without CoC - e.g. EU Nonroad St IIIA Comp

Please note

That the engines and systems (only) comply with country or region specific emission requirements and have appropriate emission certification(s) which are explicitly stated in respective technical specifications. Any export/import/operation of the engine in countries or regions with different applicable emission law requirements is at the customers responsibility.

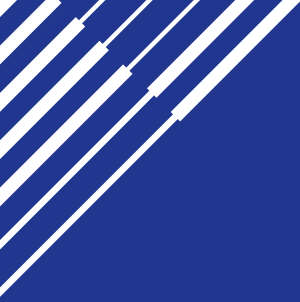

Stay posted with more powerful information
and follow **mtusolutions** under:



Rolls-Royce Group
www.mtu-solutions.com/rail

The Rolls-Royce name, Rolls-Royce badge and Rolls-Royce monogram
logos are registered Trade Marks of Rolls-Royce plc

